

CHAPTER 4

Cathedral of Ica

4.1 Summary

Ica is the largest and most important modern city on the coast of Peru between the cities of Arequipa and Lima. Located at the corner of the city's main plaza, the Cathedral of Ica was originally built in 1759 by the Society of Jesus, but its ownership was transferred to the Mercedarian Order in 1780 after the expulsion of the Jesuits from the Viceroyalty of Peru in 1767 (Figs. 4.1, 4.2). Presently owned by the Roman Catholic Diocese of Ica, the cathedral was used as a place of worship until it was damaged in the 2007 Pisco earthquake. The former Jesuit church follows the Jesuit typology established by the Church of the Gesù in Rome and is structurally similar to the Cathedral of Lima after its reconstruction in the latter half of the eighteenth century. The cathedral plan consists of a choir loft, one central nave with four structural bays, a transept, and an altar that are all covered with barrel vaults. Either side of the nave is flanked by an aisle covered with a series of small domes, and the crossing of the nave and transept is covered by a large dome with a lantern. The thick lateral walls are constructed with mud brick masonry over a fired brick base course and stone foundations. The side aisles are separated from the central nave by a series hollow quinchá pillars and arches covered with painted mud and gypsum plaster. The barrel vault and domes are also constructed with wood arches or ribs and quinchá. The Cathedral of Ica was severely damaged during the



FIGURE 4.1
Satellite image showing the location of the Cathedral of Ica in relationship to the main square of Ica.
Image: © 2013 Google. Image © 2013 Digital Globe.



FIGURE 4.2
The Cathedral of Ica, as viewed from the main plaza to the north-east.
Image: Sara Lardinois.



FIGURE 4.3
View of damages to the dome and vault resulting from the 2007 earthquake.

Image: Sara Lardinois.

1813 and 1942 earthquakes, which led to the rebuilding of its façade, including the two bell towers, in fired brick masonry. The structure has been at risk since the 2007 earthquake, which led to the collapse of sections of the barrel vault near the façade, partial collapse of the central dome, total collapse the roof over one bay of the south side aisle, and loss of plaster at the pillar and pilaster bases (Fig 4.3).

4.2 Historical Background, Context, and Significance

4.2.1 Historical background and context¹

The city of Ica is the capital of the Ica region in southern Peru. While the area had long been inhabited by varying pre-Inca and Inca cultures, the Spanish conquistador Gerónimo Luis de Cabrera claims to have founded the city in 1563. As of 2005, the city had an estimated population of 219,856. The cathedral is located at the southwest corner of the Ica's main plaza and is considered one of the most important buildings in the city (Fig.4.4). The cathedral is housed in an eighteenth century building that was originally constructed for the Jesuit College of San Luis Gonzaga² and is representative of a typical Baroque Jesuit church. Following the expulsion of the Jesuits from the Viceroyalty of Peru in 1767, the church was later occupied, renamed, repaired, and altered by a number of different religious orders, including the Mercedarians, who were responsible for rebuilding the façade following the earthquake of 1813. Since 1946, it has served as the cathedral for the Roman Catholic Diocese of Ica.

Soon after the arrival of the Spanish in Peru, the King of Spain and Holy Roman Emperor Charles V authorized four religious orders to come to Peru—the Dominicans, Franciscans, Mercedarians, and Augustinians—with the purposes of leading evangelical and educational efforts and promoting the development of cities in the New World. All four of these groups were Christian mendicant orders of friars, which first appeared in Europe at the end of the Middle Ages and spent their time preaching the Gospel and serving the poor. Monastic orders were never allowed to come to Peru.³

The first members of the Society of Jesus (*Compañía de Jesús* in Spanish) arrived in Peru in 1567–1568. Created by Ignatius of Loyola and six other students at the University of Paris in 1534, the Jesuits were neither monks nor friars, but rather a priestly order. The Jesuits were devoted to education, often operating and living in urban colleges.⁴ In order to maintain these colleges, the Jesuits invested in farms outside the cities, which also allowed them to interact with the rural population. The Jesuits were involved in several farms in the Ica region,⁵ including those at Mamacona, Belén, Caúcato, and San Jerónimo, as well as those at San Javier and San José, both in Nazca⁶. The Jesuits would be expelled from the Spanish colonies, including the Viceroyalty of Peru, in 1767 for political reasons.

The Jesuits arrived in Ica in 1739 to open the College of San Luis Gonzaga, which included the church that would later become the Cathedral of Ica.⁷ Work on the college began in 1746 and was completed in 1759, according to the date inscribed on the cathedral dome. It would seem that work continued after this date, as it is known that the master mason Gaspar Urrunaga was working at the Jesuit college in Ica from 1762 to 1767 (the year of the expulsion).⁸

Most Jesuit churches in the New World, including the former Jesuit church of Ica, have similar floor plans that are based upon the Church of the Gesù in Rome.

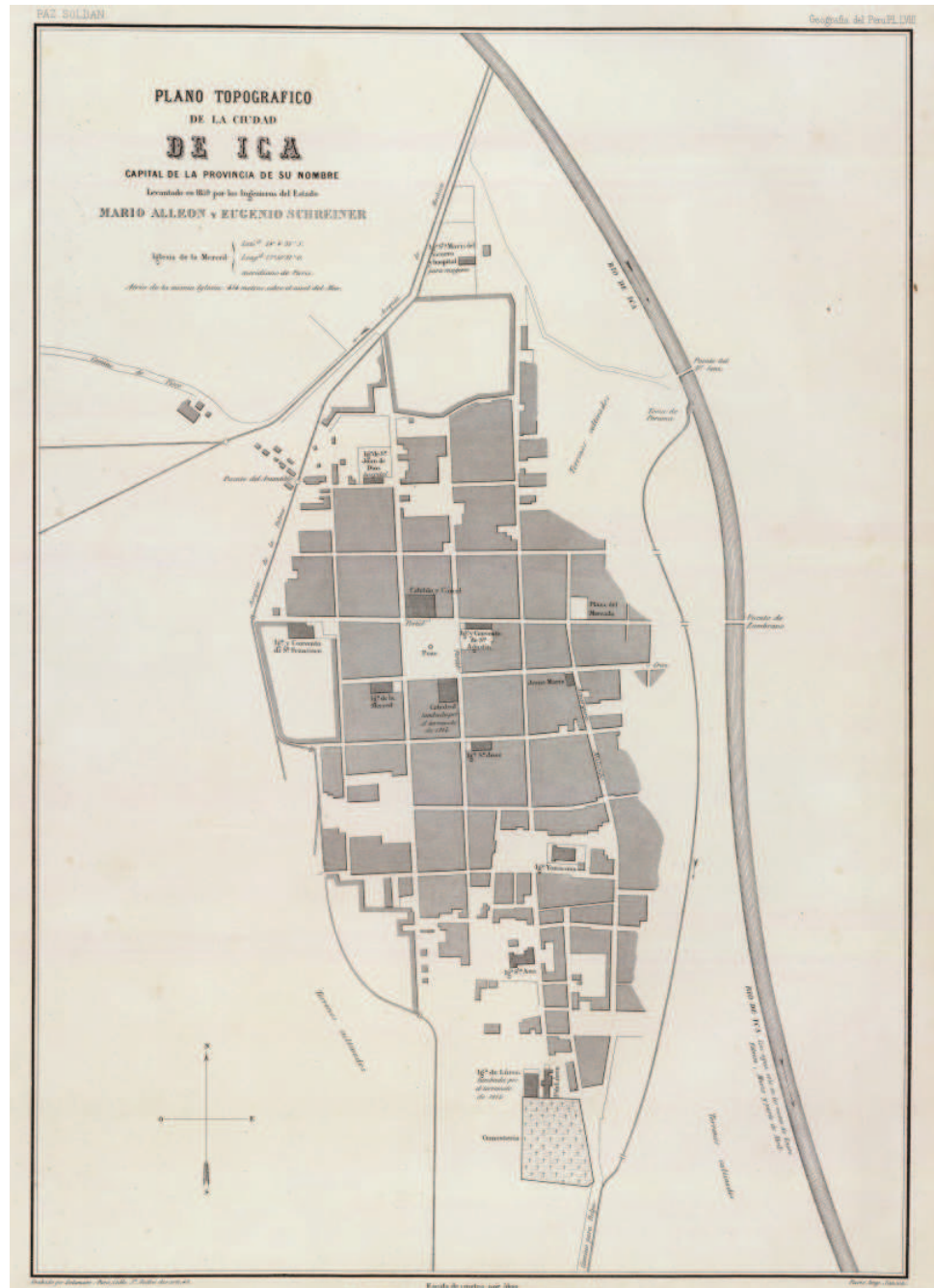

FIGURE 4.4

The 1859 *Plano topographic de la Ciudad de Ica*, showing the Cathedral of Ica, then called the Church of the Merced, at the lower left corner of the plaza. The former location of the city's main church (the original Iglesia Matriz de San Jerónimo), which was damaged in the 1813 earthquake, is shown at the lower right corner of the plaza.

Image: David Rumsey Historical Map collection, © 1985.

The typical plan has a cruciform or rectangular shape with a high barrel-vaulted nave flanked by low side aisles, which consist of a series of square spaces each covered by a dome. The shallow transept is essentially a continuation of the side aisles and is also covered by a barrel vault. A large dome with a lantern tops covers the crossing of the church. As at the Gesù, the presbytery/altar at Ica is flanked by chapels at either side; however, unlike the Gesù where the presbytery/altar terminates with a semi-circular apse, at Ica there is only a flat wall. As originally constructed, the church at Ica exhibited three of the unique Jesuit church characteristics identified by Father Rubén Vargas Ugarte:⁹

- Lack of a choir loft over the main entrance. As Jesuits were not friars and thus did not pray the Liturgy of the Hours together as a choir, there was no need for a choir loft. It is unclear if the choir loft at the Cathedral of Ica is original to the building or is a later addition made by the Mercedarians.¹⁰
- A corridor running along the sides of the upper nave, above the entablature. Where it was not possible to include a corridor within the church, as was the case at Ica, it was located outside, at the base of the barrel vault. Windows, with integral balustrades or balconies, allowed for communication between the central nave and exterior corridors. Exterior corridors are present in the former Jesuit church at Ica, as well as in other regional churches such the Hacienda San Regis, also in Ica.
- A profusion of art pieces, including paintings and sculptures, primarily intended for didactic purposes. After the expulsion of the Jesuits in 1767, many of these art pieces were given to other churches.

Following the expulsion of the Jesuits, the Mercedarian Order, which had been in Ica since the seventeenth century, took over the former Jesuit college and church. They first asked for the building in 1774 and took possession of the complex around 1780, operating under the name of Colegio Mercedario de San José. The church itself was devoted to Our Lady of the Mercy. One of the first alterations carried out by the Mercedarians was an elaboration of the main altarpiece by the master Joseph Carlo Conti in 1802. In 1813 an earthquake damaged the church as well as several other buildings in Ica including the city's main church, the Iglesia Matriz de San Jerónimo, in the nearby plaza. The Mercedarians set about repairing the church the following year. As part of this work, the front façade was rebuilt in the Neoclassical style, and the choir loft over the main entrance may have been added at this time. The decorative scheme for the front façade incorporates a number of allegorical figures which are described in greater detail in section 4.3.

Following the independence of Peru (1821–1824), religious orders with less than eight members were suppressed, and the Mercedarians left Ica. The former Jesuit church took the name of Iglesia Matriz de San Jerónimo from the damaged church in the plaza, and the college took back its former name of San Luis Gonzaga. Several alterations and repairs to the church were carried out in the nineteenth century. In 1830 a new bell was made for the church. The church suffered damages during the 1868 earthquake but was repaired in 1874.

An inventory carried out in 1878 noted the church had two bell towers (one with a clock), three bells, and several altarpieces. The German doctor and explorer Ernst Middendorf visited Ica in 1887 and reported that the church was in good condition and noted there were two altarpieces. A report made in 1900 by the archbishop of Lima describes both fixed and movable altarpieces in the church. The five fixed altarpieces included the main altarpiece, as well as lesser ones devoted to the Sacred Heart, Our Lady of the Rosary, The Nazareno, and Our Lady of the Carmel. The movable altarpieces included those devoted the Immaculate Conception of Our Lady, the Sacred Family, and Saint Ramón. The inventoried images included Our Lady of Mercy, Our Lady of the Rosary, Our Lady of Carmel, the Immaculate Conception, Saint Rose of Lima, the Holy Family, Our Lady of the Sorrows, Saint Catherine, Saint Raymond, Saint Roch, and Saint Cajetan. The report also noted the pulpit and, in front of it, a small structure with a stone sculpture depicting Christ on the Cross with Our Lady and Saint John.

The historic records indicate that the northeast bell tower, which houses the clock, was under repair in 1919, but it was later destroyed by the 1942 earthquake.

In 1946 the Roman Catholic Diocese of Ica was created and the former Jesuit church was declared the cathedral of the new diocese. The building continued to function as a cathedral until it was damaged during the 2007 earthquake. Today, the cathedral is largely unused, although diocese priests continue to celebrate mass within the damaged structure.

4.2.2 Significance

On May 30, 1958 the cloister of the old Jesuit college of San Luis Gonzaga, adjacent to the Cathedral of Ica, was registered as a national monument; however, the cathedral itself would have to wait until December 15, 1982 to be registered as a national monument. The significance of the cathedral was questioned after it incurred severe damages during the 2007 earthquake; however, the possibility of delisting the structure generated a controversy among the citizens of Ica who requested that the former Instituto Nacional de Cultura retain its status as a monument and work towards its conservation.

4.3 Architectural Description

The cathedral is located at the corner of an urban block in the historic center of Ica, at the intersection of Jirón Cajamarca and Jirón Bolívar. The cathedral is preceded by a 280 m² *atrio* (walled forecourt) and is adjacent to its original one-story mud brick Jesuit college—now housing a university—to the south and three-story modern concrete structures to the west. It is built over the remains of vaulted fired brick catacombs, which were observed when the building was opened up for the inspections. These vaulted structures can also be seen in an archaeological excavation in the cloister of the adjacent Jesuit college.

The one-story, 1,075 m² church has a rectangular floor plan oriented along an east–west axis, with a 1:2 proportion and overall dimensions of 22.5 × 48.5 m. It contains 10 different functional spaces: a *sotacoro* (area under the choir loft), choir loft, central nave, two side aisles, a crossing, transept, altar, and two side chapels flanking the altar (Fig. 4.5). Changes in floor level and interior pillars, pilasters, and piers are used to separate the different spaces (Fig. 4.6). The church is accessed through a large pair of arched doors at the front façade to the east, and the altar is located at the far west end of the building. A lateral entrance, with a pair of large doors that often remain closed, at the north wall along Jirón Cajamarca also provides access to the nave. A 195 m² sacristy, which is not the subject of this construction assessment, is located to the west of altar and can be accessed through an independent entrance at Jirón Cajamarca. A wood spiral staircase, located in the base of the southeast bell tower, provides access to the wood-framed choir loft above the *sotacoro* and to the roof (Fig 4.7).

The exterior appearance of the church is largely defined by its front façade and long lateral wall (Figs. 4.8, 4.9). Renovated in a Neoclassical style following damages incurred in the 1813 earthquake, the horizontal three-part front façade has base, a monumental pair of arched doors flanked by engaged Corinthian columns and pilasters, and a pediment, all constructed with fired brick masonry. The decorative motif for the front façade incorporates a number of allegorical figures, including a coat of arms with a lamb in the pediment and an image of Our Lady of

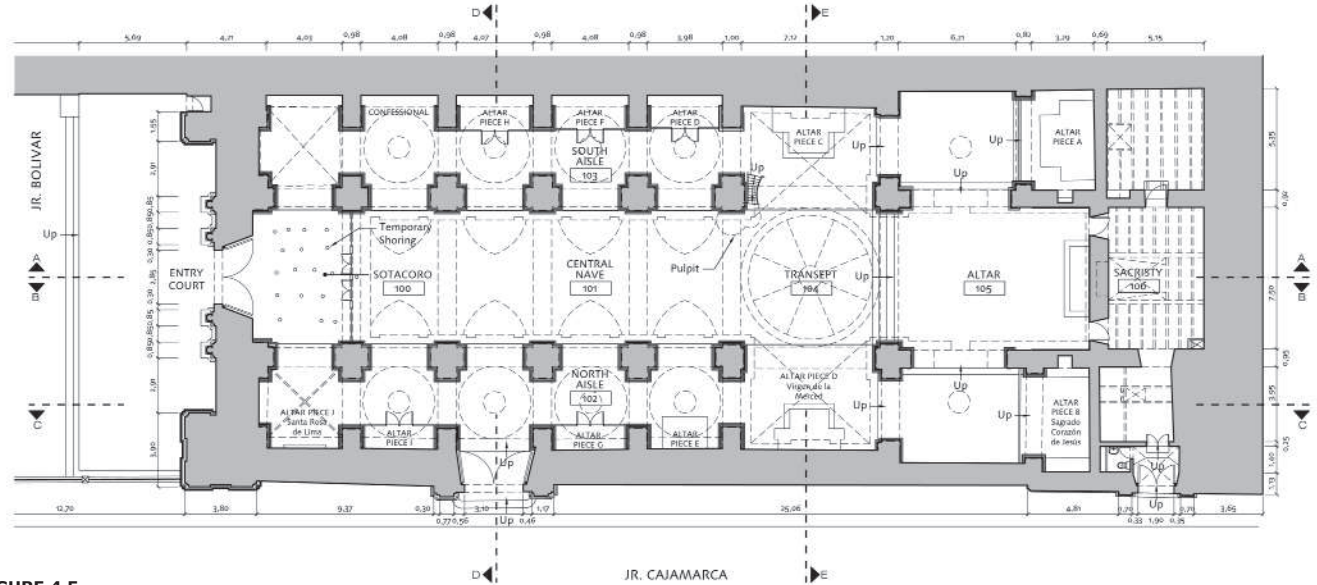

FIGURE 4.5
Floor plan, Cathedral of Ica.
Drawing: Base drawing prepared by Mirna Soto and edited by the GCI.

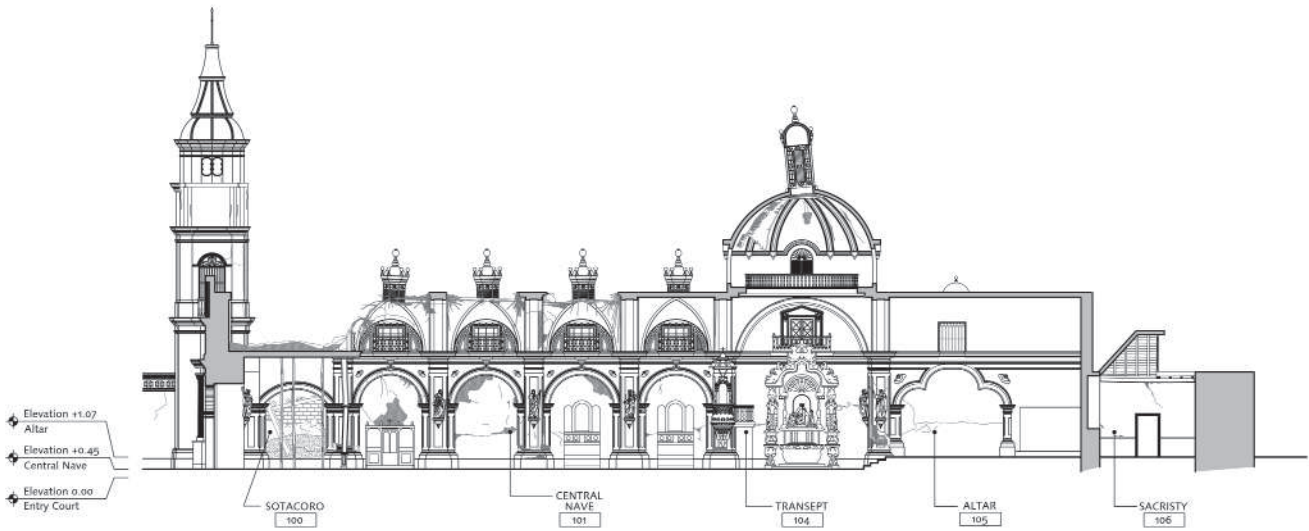

FIGURE 4.6
Cross section A-A, Cathedral of Ica.
Drawing: Base drawing prepared by Mirna Soto and edited by the GCI.

**FIGURE 4.7**

Heavy timber framing at spiral staircase in southeast bell tower, 2007.

Image: Instituto Nacional de Cultura del Perú.

Mercy crowned by angels and holding prisoners' chains in the frieze. At each side of the main entry portal, between the engaged columns, there is an allegorical sculpture. The figure to the left likely represents a Virtue, while the one to the right represents Justice. A wood-framed bell tower with a fired brick base flanks either side of the front façade. A small secondary door provides access to the base of the south bell tower. The mud brick lateral façade at Jirón Cajamarca has two openings: the lateral entrance and the sacristy entrance doors. Both the fired brick masonry front façade and mud brick lateral walls are constructed over a fired brick base course and rubble stone masonry foundations and have a plaster finish.

At the interior of the cathedral, a series of pillars, spaced at approximately 5 m on center, create four bays and are used to separate the central nave from the side aisles (Figs. 4.10, 4.11). These pillars support both the central vault and the small domes over the side aisles. Similar pillars are also used to support the central dome at the crossing of the nave and transept. The pillars are constructed with wood posts which are wrapped with flattened cane reeds and finished with mud plaster and gypsum and are decorated in the Neoclassical style. This construction technique was used in churches after the 1746 Lima earthquake as a means of replacing earlier heavy fired brick and stone masonry columns and increasing the height of the nave and crossing. Some of the pillars in the cathedral also contain a tree trunk in the center, which supports the upper roof beams.

The far east end of the cathedral, which contains the choir loft, is thought to have been modified by the Mercedarians when they rebuilt the east façade following the 1813 earthquake and is structurally different from the rest of the building. It is two stories in height and contains the choir loft, the sotacoro below, and one-storey extensions of the side aisles to the north and south of the sotacoro which have rib-vaulted ceilings with flat roofs above. A choir screen, consisting of decorative wood framework with glazed insets and two pairs of doors, separates the sotacoro from the nave.

The roof consists of a series of barrel vaults and domes, with flat roof areas between them (Figs. 4.12, 4.13). The nave, transept, and altar are all covered by barrel vaults. The barrel vault over the transept is perpendicular to the nave and altar

**FIGURE 4.8**

Detail of front façade, showing main entry to the church.

Image: Sara Lardinois.

**FIGURE 4.9**

North lateral wall along Jirón Cajamarca, 2007.

Image: Phillipe Garnier.



FIGURE 4.10
View of nave, looking towards the choir loft, sotacoro, and choir screen.
Image: Sara Lardinois.



FIGURE 4.11
View of pillars between the nave and side aisles, 2007.
Image: Philippe Garnier.

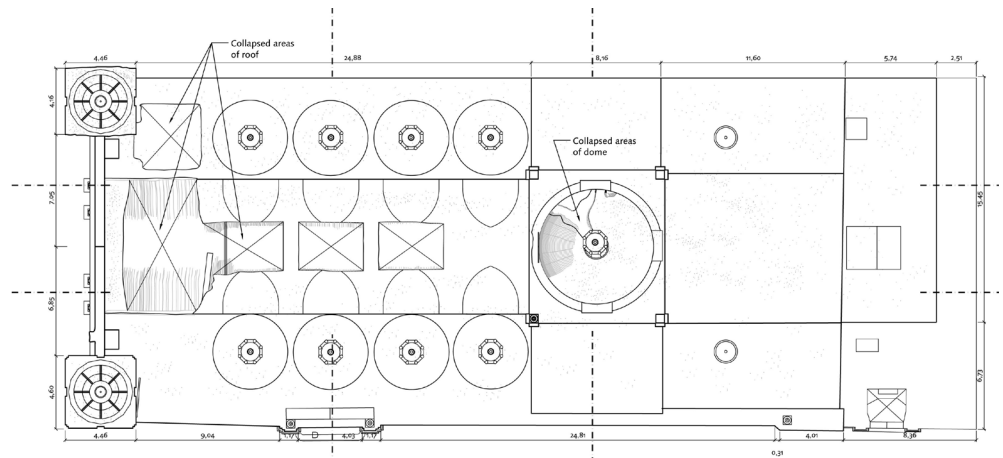

FIGURE 4.12
Roof plan.
Drawing: Base drawing prepared by Mirna Soto and edited by the GCI.



FIGURE 4.13
View of domes over south lateral aisle, with damaged main dome in the distance, 2007.
Image: Instituto Nacional de Cultura del Perú.

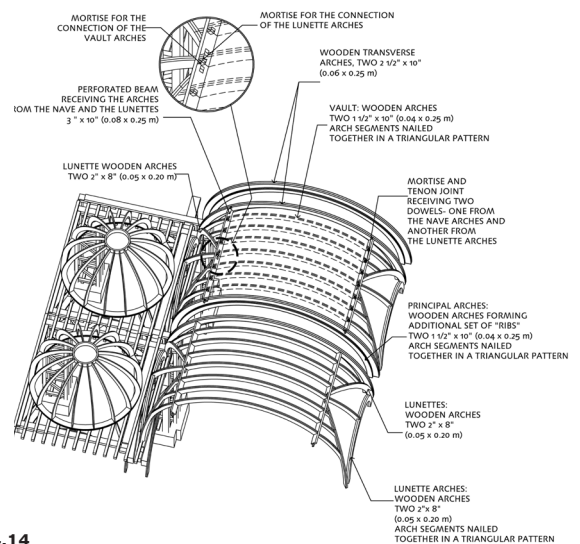

FIGURE 4.14
Detail showing the construction of the barrel vault, lunettes, and side aisle domes.
Drawing: Mirna Soto, for the GCI.

FIGURE 4.15 (LEFT)
View of main dome over the crossing of the nave and transept, with painted pendentives, 2007.
Image: Instituto Nacional de Cultura del Perú.



FIGURE 4.16 (RIGHT)
View of umbrella dome over the side aisle.
Image: Sara Lardinois.



vaults. At each side of the nave, five perpendicular vaults or lunettes, corresponding to the location of windows in the upper nave wall, intersect with the main barrel vault (Fig. 4.14). The crossing of the nave and transept is covered with a large umbrella dome, topped with a lantern and supported by a wood frame over the pillars (Fig. 4.15). Four non-structural decorative pendentives cover the internal wood structure. The aisles flanking either side of the nave are covered with eight small umbrella domes, which have a similar configuration to the central dome and are crowned with a wood lantern that illuminates the interior aisles (Fig. 4.16). These vaults and domes are constructed in quincha, with structural wood arches or ribs that are covered with canes and plaster at both the intrados and extrados.

4.4 Geological and Environmental Description

4.4.1 Geological description and seismic history

The cathedral (lat 14°3'53" S; long 75°43'47" W) is built over compacted silty sand with 1–1.5 kg/cm² of permissible load.¹¹ Although some sectors in the city of Ica are prone to liquefaction, the area where the cathedral is located is not.

The building is located in a level 3 seismic risk zone—the highest seismic level classified by the Peruvian Building Code.¹² As the church was constructed in the eighteenth century, it has been subject to a number of seismic events throughout its history, including the 2007 Pisco earthquake (M_w 8.0), approximately 65 km to the Northwest; the 1942 earthquake off the coast of central Peru (M_w 8.2); the 1868 Arica earthquake (M_w 9.0); and the previously mentioned 1813 earthquake, which destroyed the original façade of the church.¹³

4.4.2 Regional climate

Ica has a warm and dry desert-like climate. While the humidity is high along the coast, it decreases in the interior. Ica is located approximately 55 km from the Pacific coast of Peru. Average temperatures are 32°C in the summer and 17°C in winter. The cathedral is located in the moderate flood zone. According to Mitma and Alva (2005), the 100-year flood is expected to generate flows of 600 m³/s. The most recent flood of this magnitude in Ica occurred in 1998 and resulted in damage to the city. The 5-year flood is expected to generate a flow of 250 m³/s.

4.5 Structural Description

The following sections describe the different structural materials, elements, and systems making up the Cathedral of Ica and their current condition (Fig. 4.17). Irregularities, alterations, damages, and decay observed during the construction assessment survey are described in greater detail in section 4.6 that follows the structural description.

4.5.1 Survey sectors

For the purpose of conducting the construction assessment survey, the church was divided into six sectors (Fig. 4.18). The sectors were selected based upon differences in plan configuration, height, and construction details. The sectors are as follows:

- **Sectors A-1 and A-2:** The east end of the cathedral, including the spaces at altarpieces J and K, the sotacoro (A-1), and the choir loft above (A-2).
- **Sector B:** The south side aisle adjacent to the original Jesuit college.
- **Sector C:** The central nave between the side aisles.
- **Sector D:** The north side aisle adjacent to Jirón Cajamarca.
- **Sector E:** The transept and dome, including altarpieces C and D.
- **Sector F:** The main altar, including altarpieces A and B, at the far west end of the cathedral.

4.5.2 Foundations and base course

The Cathedral of Ica is constructed with a manmade base course and foundation. The base course is typically constructed using fired brick masonry and sometimes also rubble stone masonry. The foundations are comprised of rubble stone masonry. A sand and lime mortar is used for both the base course and foundation. The configuration and dimensions of the base course and foundations vary throughout the cathedral.

The front façade at the east side of the church is constructed of fired brick masonry with a lime mortar. Prospection IS-1, at the base of the north bell tower on the front façade, revealed that at the pillars base the fired brick extends approximately 0.30 m below the interior floor level. Below this is a 1.00 m deep foundation constructed of rubble stone masonry. This stone foundation is wider, projecting approximately 0.15 m beyond the face of the fired brick masonry wall above.

At the mud brick north lateral wall, there is a 0.90 m high fired brick masonry base course over a 0.40 m high rubble stone masonry wall (prospection IW-2). Rubble stone masonry is also used for the foundation below; however, its depth was not confirmed through any prospections along this wall. The width of the base course is the same as the mud brick wall above. Both the base course height and material composition changes at the east end of the north lateral wall, in the transitional zone between the fired brick north bell tower and the mud brick lateral wall. In this area the stone base course is interspersed with courses of fired brick and continues to a height 1.75 m above the interior floor level. Above this, fired brick construction continues up to 3 m above the interior floor level—approximately to the height of the ceiling over the side aisle. According to architect Mirna Soto, who was responsible for carrying out the prospections, this transitional technique is also extant in a church located two blocks away and dating to the same period as the cathedral (Fig. 4.19).

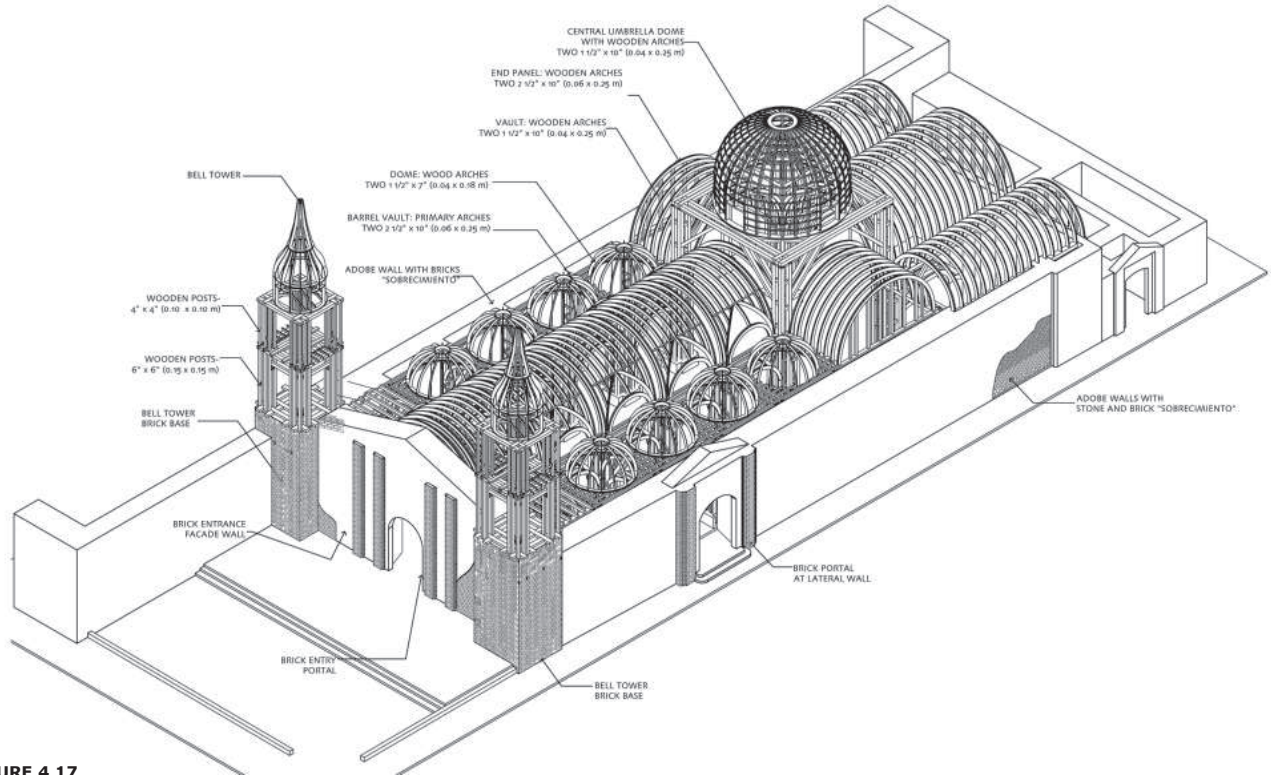

FIGURE 4.17
Overall structural scheme for the cathedral.
Drawing: Mirna Soto, for the GCI.

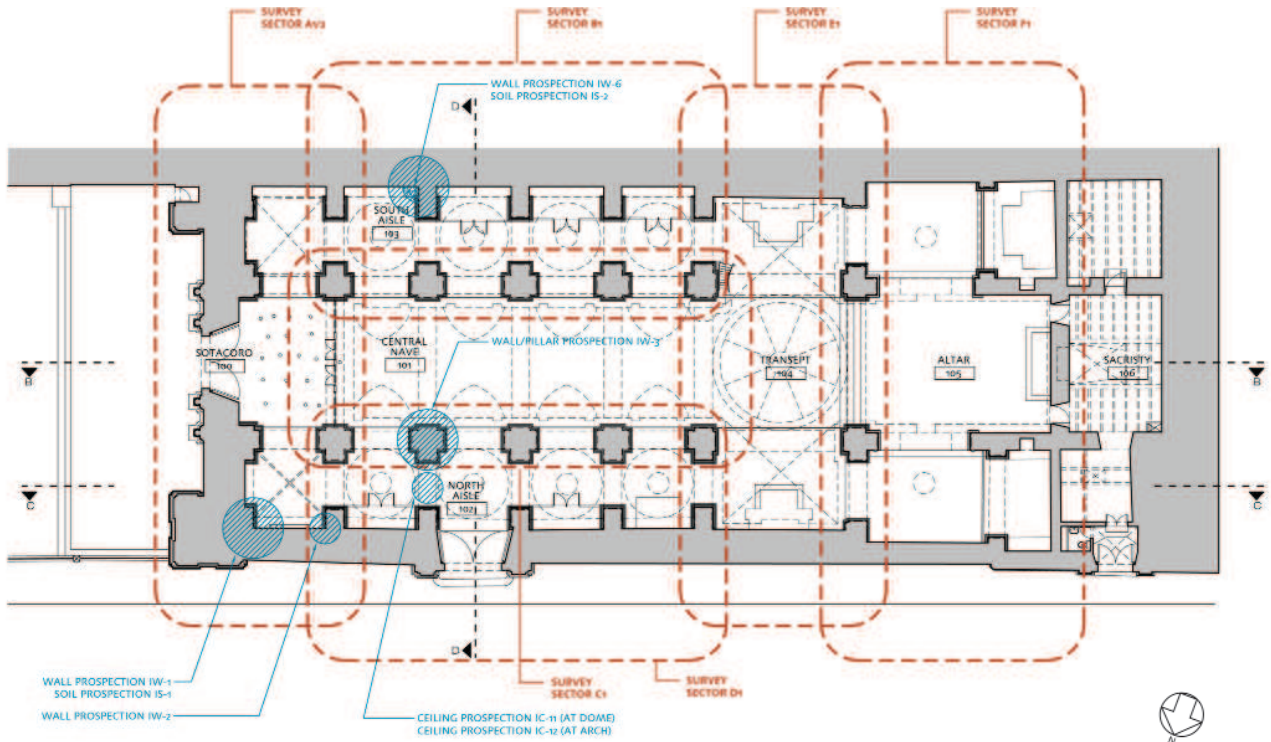
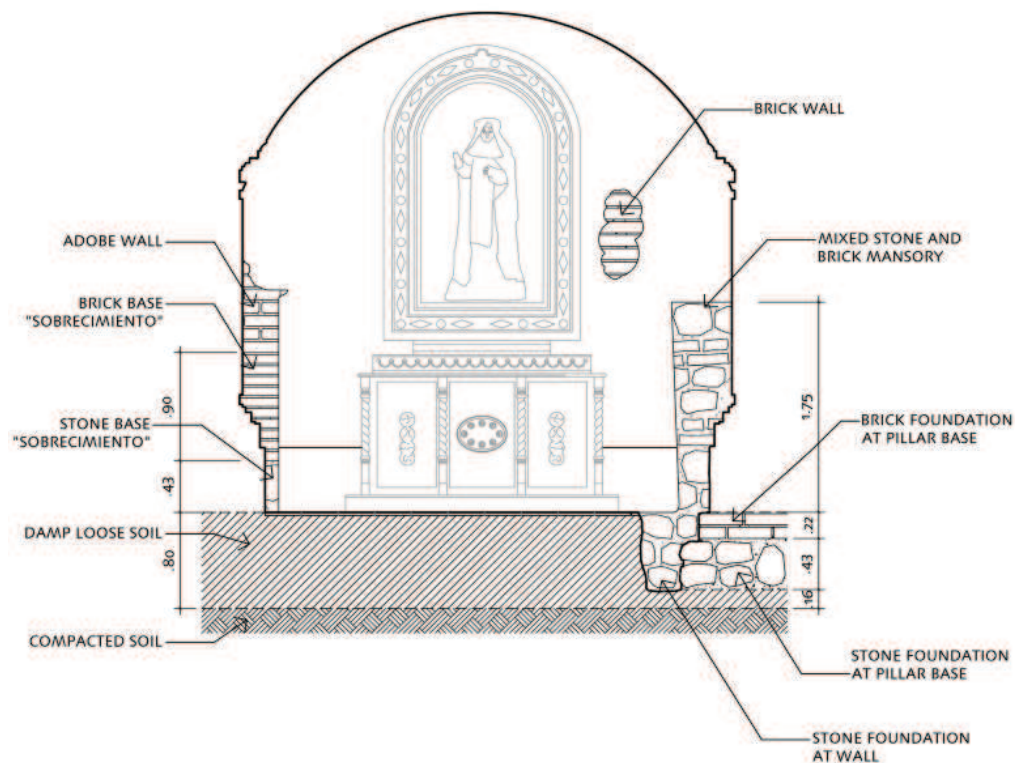

FIGURE 4.18
Floor plan, showing sector and prospection locations.
Drawing: Base drawing prepared by Mirna Soto and edited by the GCI.

FIGURE 4.19

Prospection IW-2–IS-1, elevation view showing the foundation at the north lateral wall, adjacent to the bell tower.

Drawing: Mirna Soto, for the GCI.



At the mud brick south lateral wall, the base course consists of a 0.60 m high fired brick masonry wall over a 0.48 m deep rubble stone foundation (prospection IS-2). Below this, the remains of vaulted fired brick catacombs were found. Both the base course and foundation are the same width as the mud brick wall above.

The interior wood-framed pillars have fired brick foundations that extend from 0.50 m below the floor level to 0.70 m above it to create a pillar base. The engaged pillars, or pilasters, along the lateral walls are located immediately adjacent to mud brick piers or buttresses and have fired brick base courses and stone foundations similar to those at the mud brick walls. It is important to note that the bricks at the pier bases do not interlock with the brick base course along the lateral wall.

4.5.3 Walls

The external walls are of load-bearing fired and mud brick construction, typically finished with mud plaster and painted gypsum. Cement plaster is used at the exterior base of the lateral wall along Jirón Cajamarca.

4.5.3.1 Load-bearing fired brick masonry walls

The 21 m long front façade is constructed of fired brick masonry with a lime mortar. At the lower levels, it has an approximate overall thickness of 2.25 m and a slenderness ratio of 2.4.¹⁴ Thus the front façade is considered stable, with a low probability of lateral overturning. The top of the lower brick wall is connected to

FIGURE 4.20

Prospection IS-2—IW-6, showing the fired brick reinforcing behind the mud brick piers along the south lateral wall.

Drawing: Mirna Soto, for the GCI.

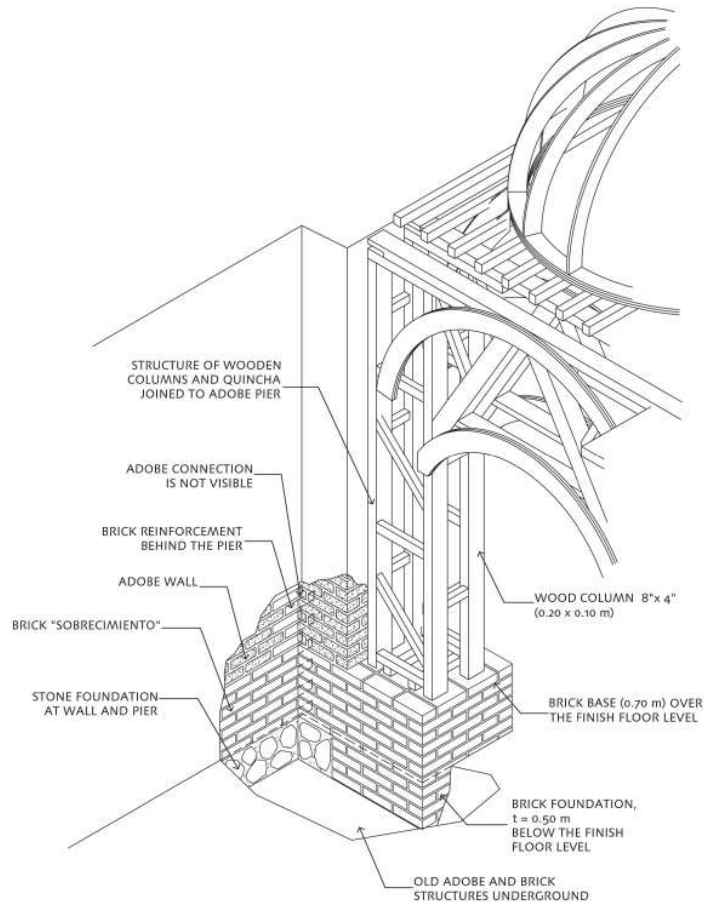

the choir loft floor framing, by the 0.10 m embedment of the choir loft floor joists into the wall. In the upper portions of the façade, at the level of the pediment, the wall is significantly thinner (approximately 0.60 m thick) and thus has a higher slenderness ratio. There is not an effective joint between the pediment level and lower portions of the wall. Thus, the high slenderness ratio and lack of an effective joint make the pediment more vulnerable to lateral overturning. The brick masonry bases for the wood-framed bell towers above project from either end of the front façade wall (see section 4.5.5 for further description of the bell towers). It is assumed that there are cavities within the brick bell tower bases for stairs or storage rooms; however, the presence or dimensions of any such cavities were not verified during the construction assessment survey.

4.5.3.2 Load-bearing mud brick masonry walls

The lateral walls are constructed of mud brick masonry with a mud mortar. There are a series of mud brick piers along each of the lateral walls, behind each of the wood-framed pilasters in the side aisles. Fired brick reinforcing, within the mud brick walls, is used behind each of the piers (Fig. 4.20).

Both the north and south lateral walls have a slenderness ratio of 3.35 and thus can be classified as very thick. According to Tolles et al. (2002) adobe walls with a slenderness ratio less than five are considered to be very stable during earthquakes and have a low probability of lateral overturning.

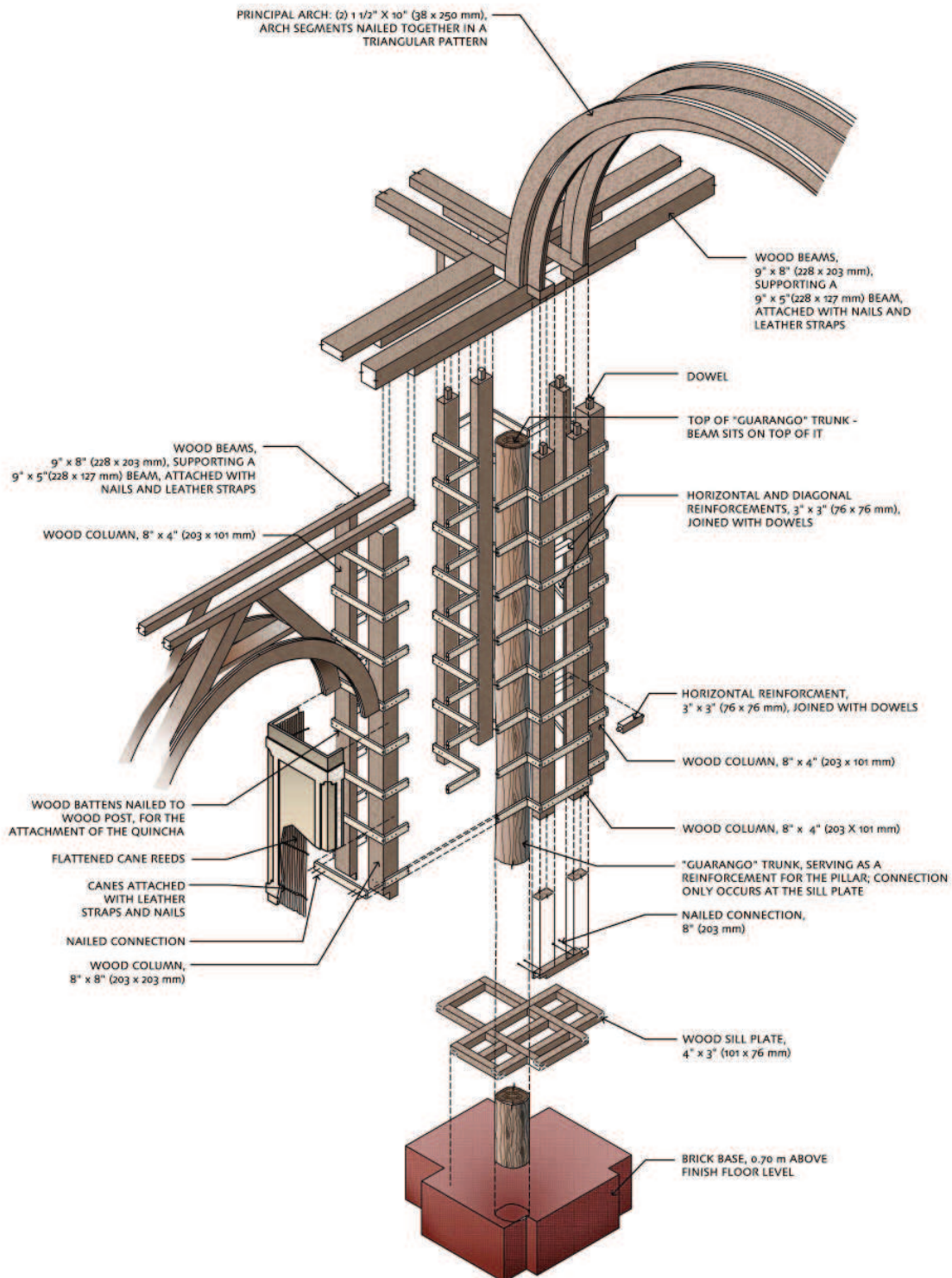

FIGURE 4.21
Prospection IW-3, exploded view showing the quincha pillar construction.
Drawing: Mirna Soto, for the GCI.

4.5.4 Pillars and pilasters

A series of wood-framed quincha pillars, spaced at approximately 5 m on center, are used to separate the central nave from the side aisle. These pillars support both the barrel vault over the nave and the joists and beams at the base of the side aisle domes. Four pillars at the crossing of the nave and transept support the main dome. The pillars are essentially hollow structures composed of eight 8" × 8" (0.20 × 0.20 m) and 8" × 4" (0.20 × 0.10 m) vertical wood posts. The tops of the pillar posts are connected with dowels to the beams, or arcade plate, above. The bottoms of the posts are nailed to a 4" × 3" (0.10 × 0.08 m) sill plate that is embedded in the fired brick base. At each side of the pillar, there are 3" × 3" (0.08 × 0.08 m) horizontal and diagonal wood reinforcements, joined to the posts with dowels. A huarango tree (*Acacia macracantha*) trunk, approximately 0.33 m in diameter, is located in the center of each pillar. The arcade plate rests on top of this tree trunk, but the two elements are not connected. The bottom of the tree trunk is connected to the sill plate below. Horizontal wood battens, nailed to the wood framing at 0.40 m on center, provide a nailing surface for the pillar finish. The pillars are wrapped in *caña chancada*, or flattened cane reeds, which are attached to the battens with nailed leather straps.¹⁵ The reeds are then finished with plaster (Figs. 4.21, 4.23, 4.24).

In the side aisles, there are a series of pilasters adjacent to the mud-brick piers along the lateral walls (Fig. 4.22). These pilasters are similar in construction to the pillars; however, they are constructed with just four wood posts and there is not a huarango tree trunk in the center of the pilasters.

The nave pillars are joined in the East-West direction by series of wood arches, and another set of arches running in the North-South direction connect the pillars to the lateral wall pilasters. Arches are also present at the lateral walls, at the intersection of the transept and mud brick wall.



FIGURE 4.22
View of quincha pilaster along the lateral wall.
Image: Sara Lardinois.

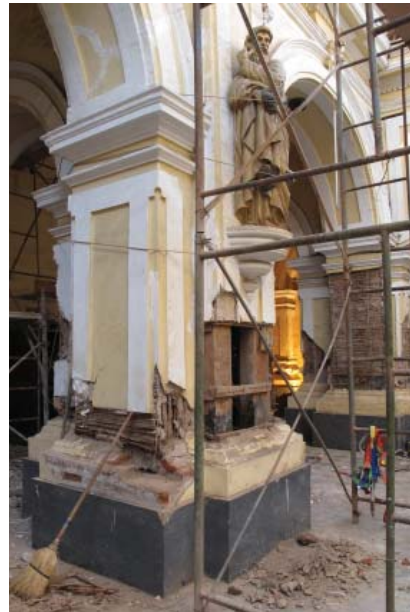

FIGURE 4.23
View of quincha pillar.
Image: Sara Lardinois.



FIGURE 4.24
View of pillar base, above brick base.
Image: Sara Lardinois.

4.5.5 Bell towers

There are two bell towers at the front façade, each measuring approximately 3.80×3.80 m in plan. They are constructed with wood framing which sits on top of the fired brick masonry wall below; and the wood-framed portion of the tower, including the cupola, is approximately 14 m high. The tower walls are framed with $6'' \times 6''$ (0.15×0.15 m) wood posts. The post bases are connected to wood plates or beams that are embedded in the fired brick wall below, similar to the construction detail at the base of the interior pillars and pilasters. Diagonal wood framing is used to reinforce the posts. Wood joists and beams are used to create an intermediate floor level within the tower; and $10'' \times 8''$ (0.25×0.20 m) wood beams, joined with half-lap joints sit on top of the posts. These beams support the wood-framed cupola above. The bell towers were originally wrapped with canes and finished with gypsum plaster; however, that finish has since been replaced with cement plaster over a wire mesh lath (Fig. 4.25).

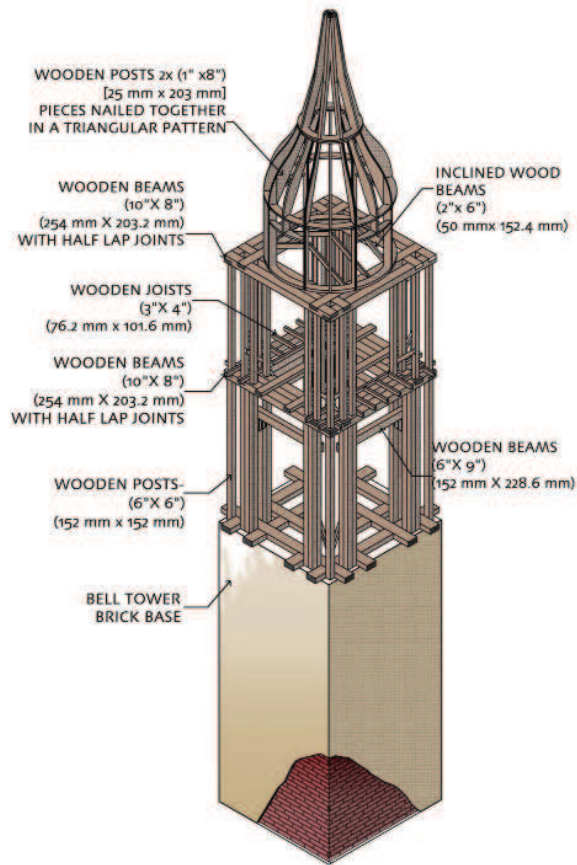

FIGURE 4.25

Isometric showing the bell tower structure.

Rendering: Jabdiel Zapata, for the GCI.

FIGURES 4.26 (NEAR RIGHT) AND 4.27 (FAR RIGHT)

Prospection IC-7, showing the embedment of choir loft floor joists in the fired brick masonry front façade.

Drawing: Mirna Soto, for the GCI.
Image: Claudia Cancino.

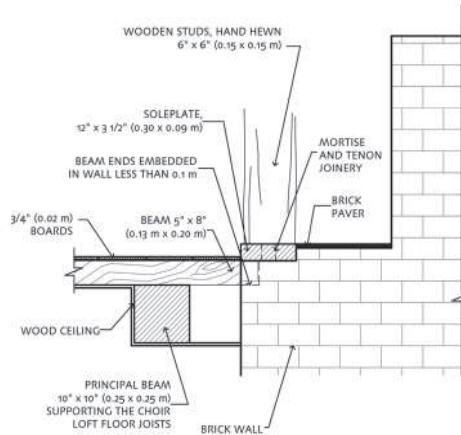
**FIGURE 4.28**

Section perspective illustrating the choir loft floor framing and roof structure at the adjacent side aisles.

Rendering: Jabdiel Zapata, for the GCI.

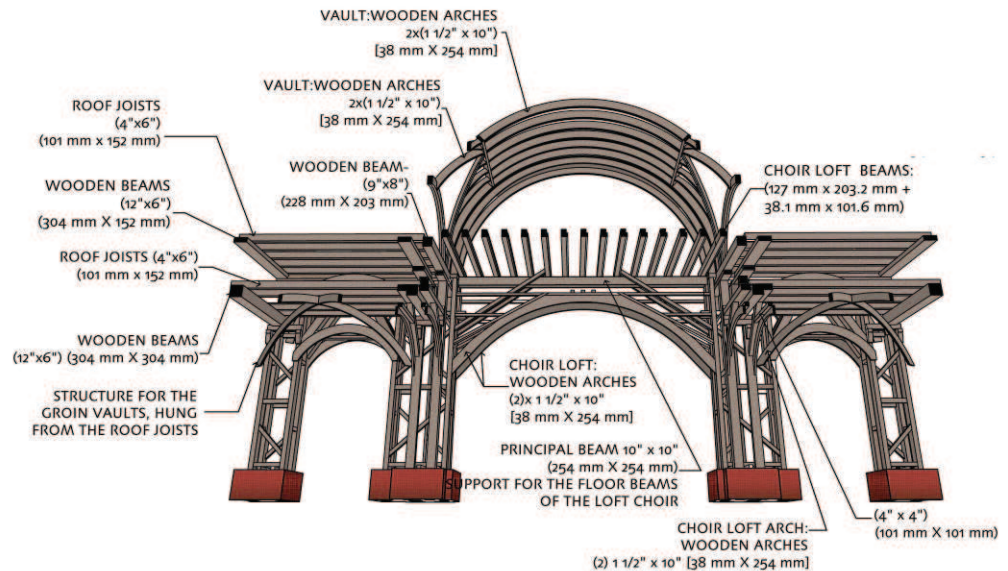
**4.5.6 Floors**

The choir loft, located in the first structural bay to the west of the main façade, spans the width of the central nave and has a wood-framed floor that corresponds to the level of the upper structural roof at the adjacent side aisles (see section 4.5.7) (Fig. 4.28). The floor framing consists of $\frac{3}{4}$ " (19 mm) thick wood boards over 5" × 8" (0.13 × 0.20 m) wood joists, with ends that are embedded up to 0.10 m into the adjacent brick wall at the main façade (Figs. 4.26, 4.27). The joists sit on 10" × 10" (0.25 × 0.25 m) wood beams that are supported by the quinchá pillars and pilasters. At the west side of the floor, below the 10" × 10" (0.25 × 0.25 m) beam, there are two 1½" × 10" (0.04 × 0.25 m) wood arches with diagonal reinforcements at the spandrel. The west side of the choir loft is open to the main nave, with a decorative wood balustrade mounted to the edge of the floor framing.

4.5.7 Roof

The roof framing system consists of a series of quincha barrel vaults over the central nave, transept, and altar; quincha domes over the side aisles; and a large quincha dome at the crossing of the nave and transept. At each side of the nave, five perpendicular quincha vaults or lunettes, corresponding to the location of windows in the upper nave wall, intersect with the main barrel vault (Figs. 4.29, 4.30).

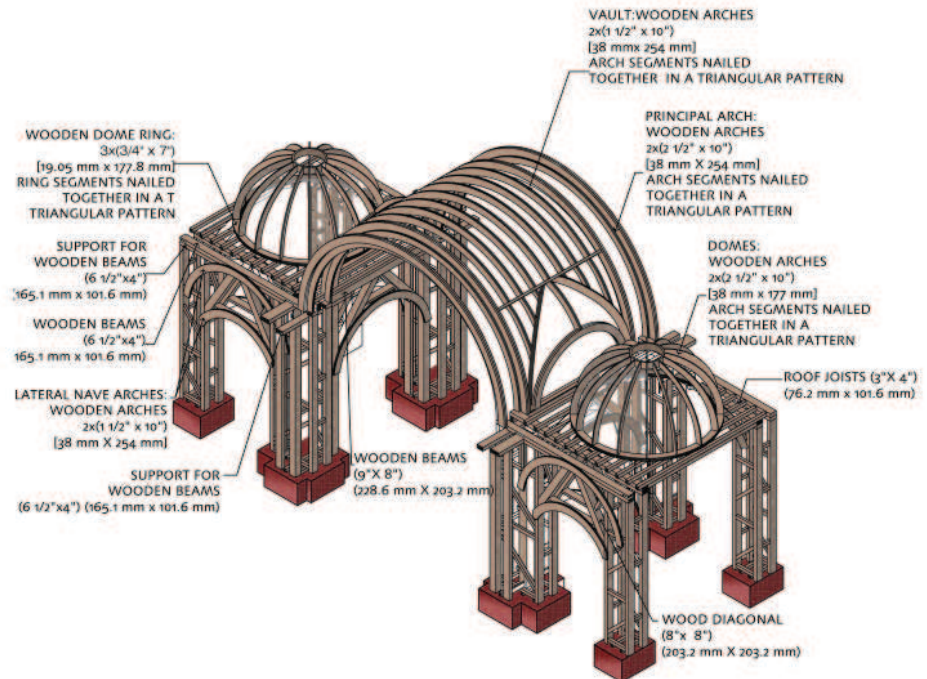

FIGURE 4.29

Isometric drawing illustrating the roof construction at the central nave and side aisles.

Rendering: Jabdiel Zapata, for the GCI.

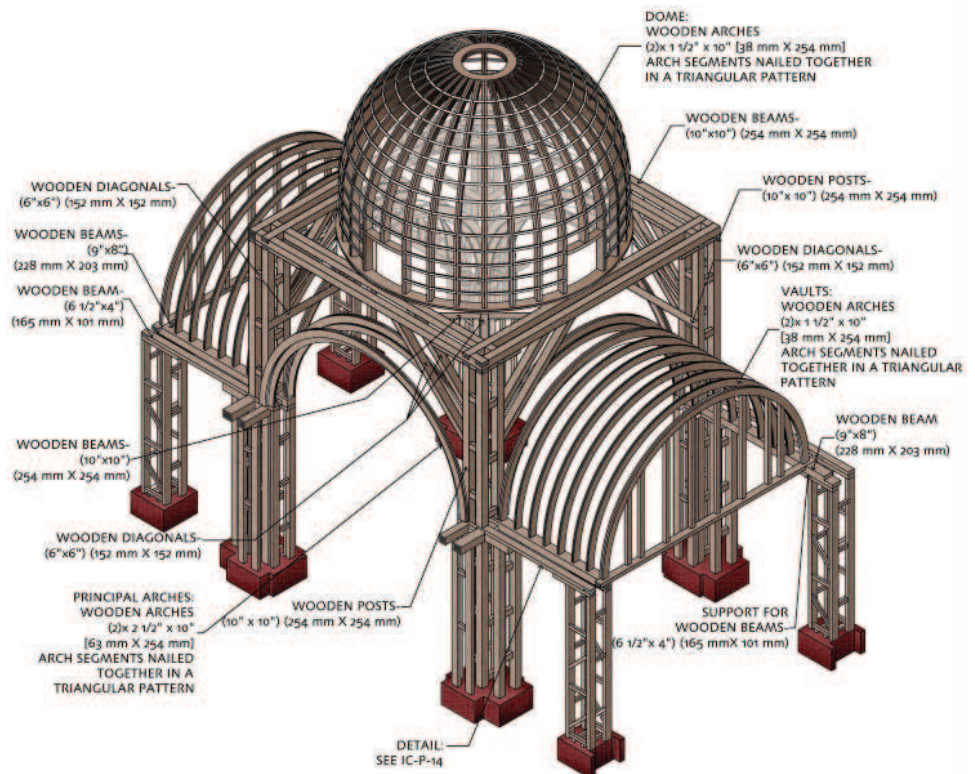

FIGURE 4.30

Isometric drawing illustrating the roof construction at the crossing and transept.

Rendering: Jabdiel Zapata, for the GCI.

At the central nave, transept, and altar, the barrel vaults are constructed with a series of principal and secondary wood arches. Two principal arches align with each of the pillars; and the ends of the arches rest on wood beams, or arcade plates, which are supported by the pillars below. Each principal arch consists of a pair of $2\frac{1}{2}'' \times 10''$ (0.06×0.25 m) wood arches. The supporting arcade plate consists of $9'' \times 8''$ (0.23×0.20 m) and $9'' \times 5''$ (0.23×0.13 m) beams joined with nails and leather straps. The wood pillar posts below are doweled into this plate. Between the primary arches, there are a series of secondary arches, as well as arches that form the lunettes. The ends of the secondary arches and the tops of the lunettes are supported by a $3'' \times 10''$ (0.08×0.25 m) wood beam spanning between the principal arches. This beam is perforated with multiple mortise holes to receive the tenons of the secondary arches and lunette framing. The secondary arches consist of pairs of $1\frac{1}{2}'' \times 10''$ (0.04×0.25 m) wood arches spaced approximately 0.60 m on center. The lunettes are formed by two $2'' \times 8''$ (0.05×0.20 m) arches. At the primary and secondary arches, as well as the lunette arches, each arch is composed of several segments which are lapped and connected with iron nails set in a triangular pattern (Fig. 4.31). At the intrados, or interior side, of the nave vault, a wide rib projects below the surface of the vault and spans between the pillars. These ribs are formed by an additional set of arches, of a smaller radius, that hang below the principal arches.

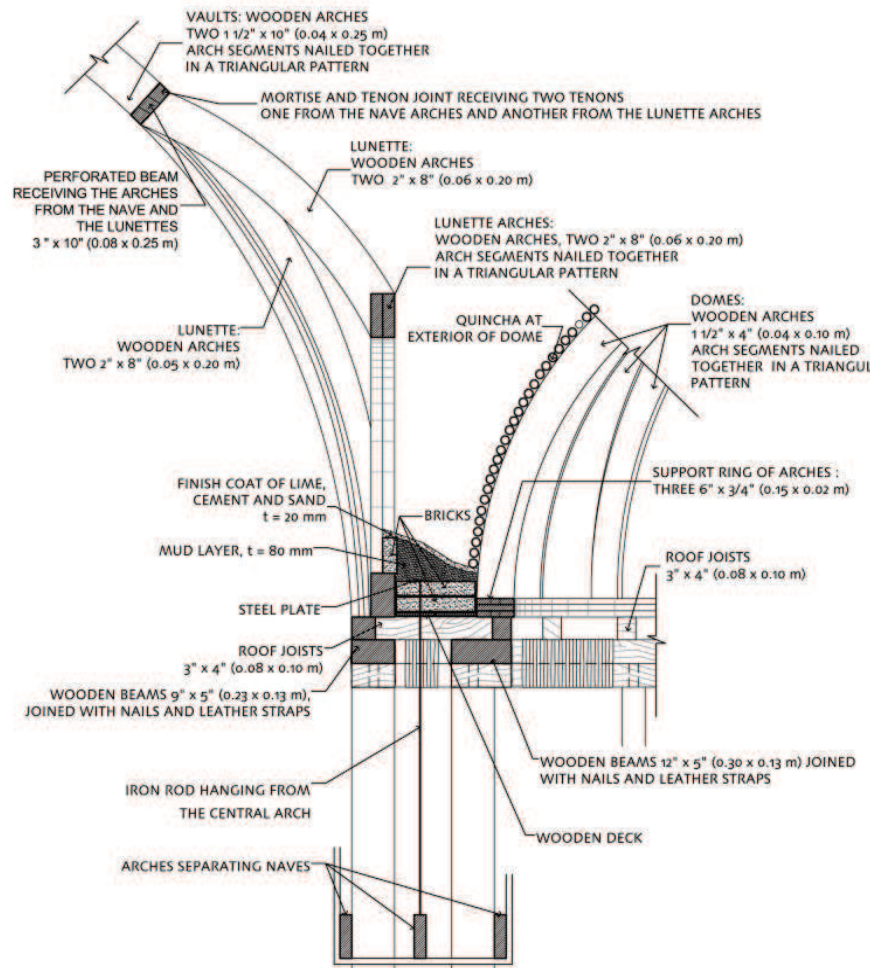

FIGURE 4.31

Prospection IC-2, section showing the construction of the nave vault and lunettes and the side aisle domes.

Drawing: Mirna Soto, for the GCI.



FIGURE 4.32 (ABOVE LEFT)
View of plaster and *caña chancada* (flattened cane reeds) at the interior side of the vault.
Image: Mirna Soto, for the GCI.



FIGURE 4.33 (ABOVE RIGHT)
View of plaster and *caña brava* (cane reeds) at the exterior side of the vault.
Image: Mirna Soto, for the GCI.

The intrados of the vault is covered with plaster and *caña chancada* attached to the wood arches with nailed leather straps (Fig. 4.32). The exterior side is covered by *caña brava* attached with nails and finished with layers of mud plaster (Fig. 4.33).¹⁶ The entire exterior surface of the vault, as well as the rest of the roof, was covered at some point with an additional layer of sand, lime, and cement mortar which adds weight to the structure.

At the east end of the vault, over the choir loft, a wood-framed semi-circular end panel beneath the final set of principal arches remains at the far east end (Fig. 4.34). This panel is constructed with eight wood posts, and the tops of these posts are connected to the arch above with mortise-and-tenon joints. The bottoms of the posts are joined with a sill plate which sits on top of the choir loft floor joists. This end panel is parallel to the façade pediment but is not connected to it—leaving a gap of 1.5 m between the vault end panel and the pediment. This gap allowed for access from the stairs in the south bell tower to the north tower. At the west end, the vault structure sits on top of the mud brick wall separating the altar from the sacristy to the west, and the ends of the transept vault sit on top of the lateral mud brick walls.



FIGURE 4.34
View of semicircular end panel that once formed the end of the barrel vault above the choir loft, which collapsed during the 2007 earthquake.
Image: Sara Lardinois.

The central dome is an umbrella dome that rises 2 m above the top of the adjacent barrel vaults and is crowned with a wood lantern. The dome is built with two $1\frac{1}{2}'' \times 8''$ (0.04×0.20 m) wood ribs, composed of several segments which are lapped and connected with iron nails set in a triangular pattern. The ribs are connected by horizontal wood pieces that form a series of rings parallel to the base of the dome. The ends of the ribs sit on the main collar ring which is comprised of two horizontal wood rings joined with mortise-and-tenon joints. This collar ring at the base of dome sits on a square frame made of two $10'' \times 10''$ (0.25×0.25 m) wood beams joined at the corners with half lap joints and leather straps and nails and reinforced with $6'' \times 6''$ (0.15×0.15 m) wood diagonals in the corners. This frame is supported by and connected with leather straps to the $10'' \times 10''$ (0.25×0.25 m) wood posts that form the pillars at the cathedral crossing (Fig. 4.35). At the interior, the frame is concealed by non-structural pendentives. Similar to the barrel vaults, the interior of the dome is covered with *caña chancada* that runs parallel to the wood rings, is attached to the wood members with nailed leather straps, and is finished with gypsum plaster. The exterior of the dome is covered with *caña brava* attached to the wood structure and is finished with mud plaster (Fig. 4.36).

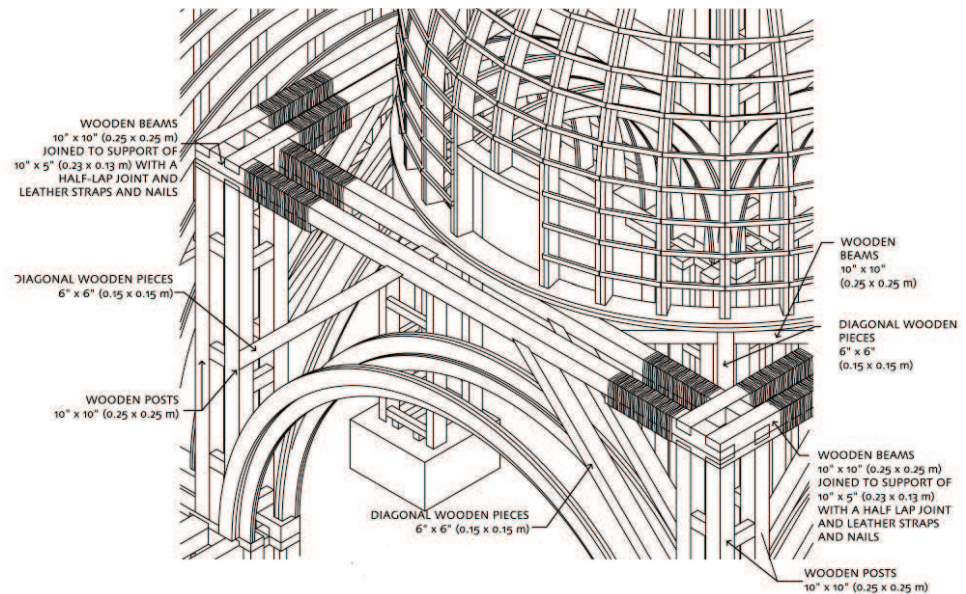

FIGURE 4.35

Prospection IC-5, showing the frame that supports the base of the central dome.

Drawing: Mirna Soto, for the GCI.



FIGURE 4.36

Exterior view of the central dome, showing the *caña brava* (cane reeds) and plaster at the exterior of the dome.

Image: Amila Ferron.

The north and south side aisles are covered with eight umbrella domes that have a similar structure to that of the central dome, but with smaller framing members. The side aisle domes are constructed with $1\frac{1}{2}'' \times 4''$ (0.04×0.10 m) wood ribs, joined at the base to a wood collar ring over wood joists. The extrados and intrados of the domes have the same characteristics of the central dome (Figs. 4.37, 4.38).

The east end of the side aisles, in the area of the sotacoro, have rib-vaulted ceilings which are purely architectural and do not perform any structural function. The rib vaults are composed of four intersecting diagonal wood ribs enclosed by wood arches that are wrapped with cane reeds that are attached to the ribs with nailed leather straps and are finished with painted mud and gypsum plaster. Above the wood rib vaults there is a structural flat wood roof made up of $12'' \times 12''$ (0.30×0.30 m) wood beams supporting $4'' \times 6''$ (0.10×0.15 m) wood joists. Half a meter above this roof there is a second structural flat roof made up of $12'' \times 6''$ (0.30×0.15 m) wood beams (Fig. 4.39). This upper roof corresponds to the level of the choir loft floor (see section 4.5.6).

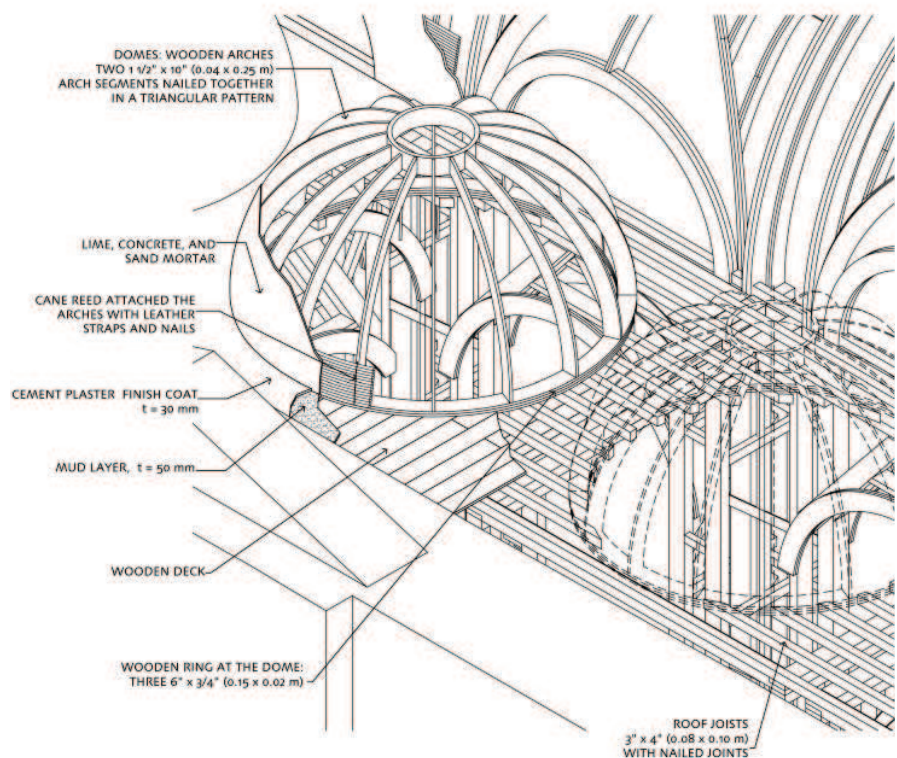

FIGURES 4.37 AND 4.38

Prospection IC-9, illustrating the construction of the umbrella domes over the side aisles.

Image: Sara Lardinois.

Drawing: Mirna Soto, for the GCI.

FIGURE 4.39

Prospection IC-10, illustrating the construction over the east end of the side aisles, adjacent to the bell towers.

Drawing: Mirna Soto, for the GCI.

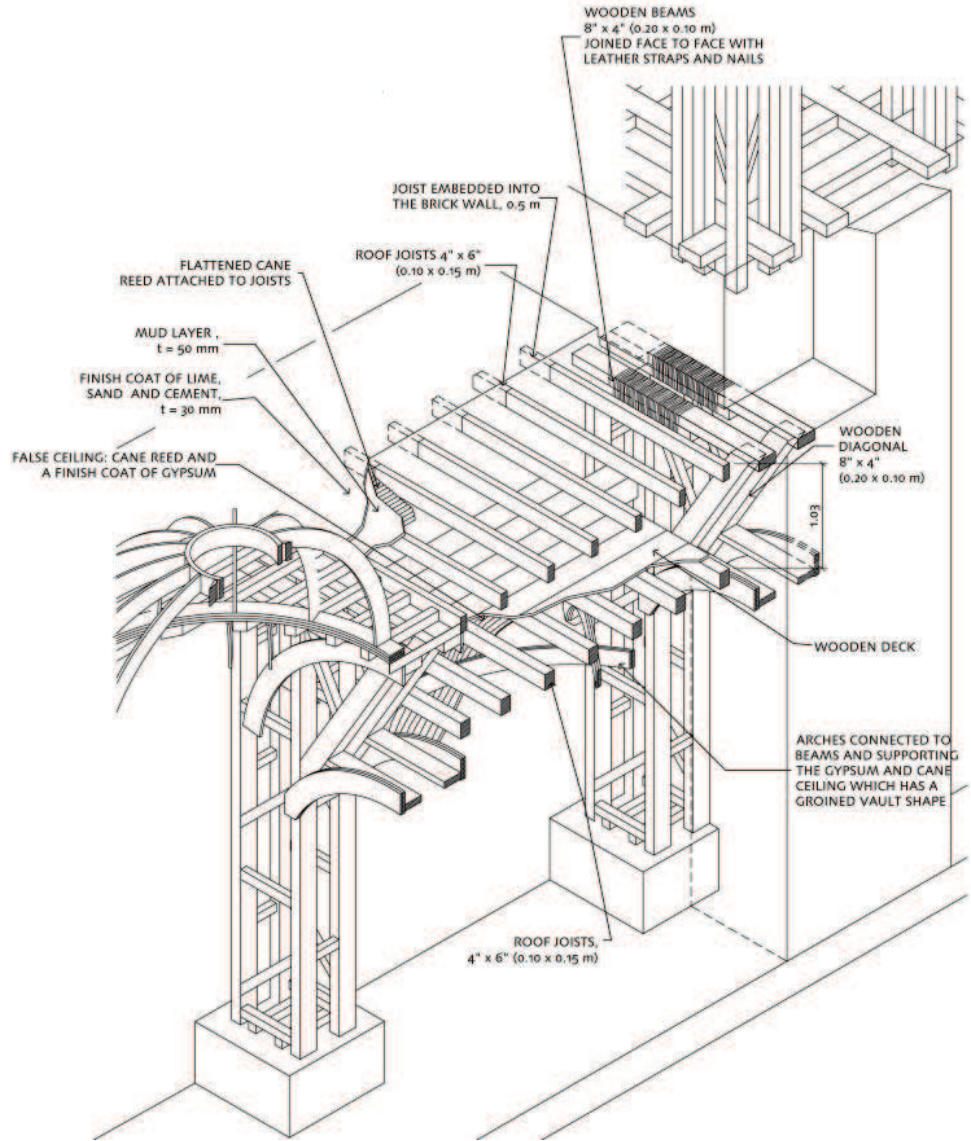

4.6 Irregularities, Alterations, Damages, and Decay

The following sections describe the current condition of the different structural materials, elements, and systems making up the cathedral and any irregularities, alterations, damages, and decay that were visually observed during the construction assessment survey. Many of the damages related to the 2007 earthquake involve a number of different structural elements and systems and are particular to a certain sector of the building. Thus, this section of the report describes conditions, as well as damages, by sector rather than by element or system.

4.6.1 Sector A-1: Front façade and bell towers

- The principal façade is in fair to poor condition. There are horizontal cracks between the lower façade and the pediment. Diagonal cracks were observed between the upper cornice and the base of the bell towers. This diagonal cracking suggests pounding of the towers during the earthquake (Fig. 4.40).
- The wood-framed portions of the towers are in poor condition and thus present a threat to the cathedral's roof system to the west. Damages include the failure of some connections, displacement of the wood elements at the south tower from their original positions, and loss of plaster. Thus, the wood posts are exposed and show signs of severe termite damage. (Fig. 4.41).

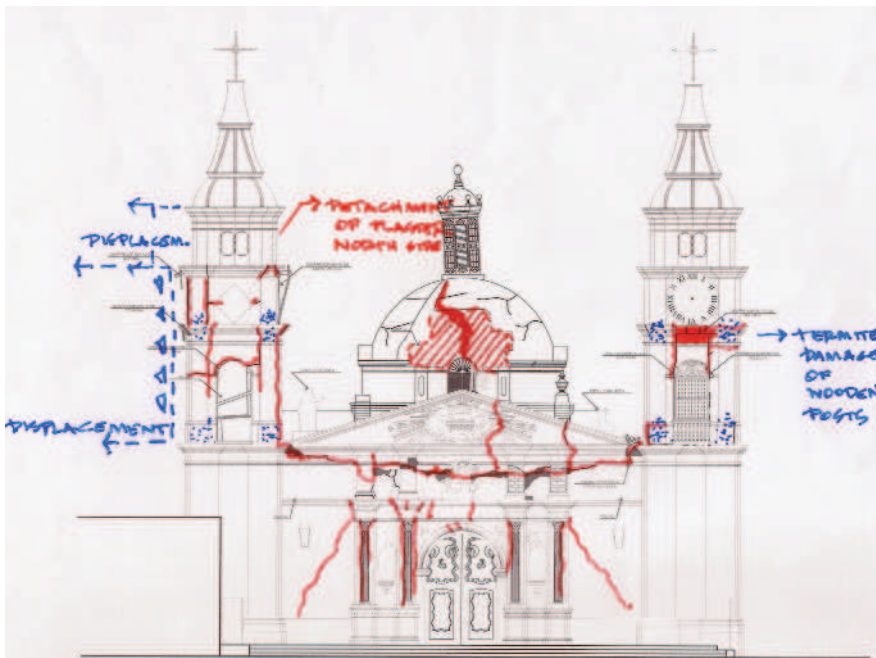

FIGURE 4.40

Front façade, graphic condition survey indicating cracks and areas of plaster loss in red and displacement and termite damage in blue.

Drawing: Claudia Cancino.



FIGURE 4.41

Loss of plaster at the south bell tower.

Image: Sara Lardinois.

4.6.2 Sectors A-1 and A-2: Sotacoro and choir loft (Fig. 4.42)

- Horizontal and vertical cracking along the perimeter of all arches and piers at the north lateral wall, in the altarpiece J (Saint Rose of Lima) space.
- Disconnection between the rib vault at the northeast corner and the north lateral wall.
- Deformation of the choir loft floor and the choir screen below.
- Vertical cracking along the pillars separating the sotacoro from the nave and structural disconnection between the pillars and adjacent choir screen.
- Total collapse of the rib-vaulted ceiling and flat roof above the altarpiece K space (southeast corner), occurring after the 2007 earthquake sometime between November 2007 and May 2009 (Figs. 4.43, 4.44).
- Collapse of the barrel vault that originally covered the choir loft.

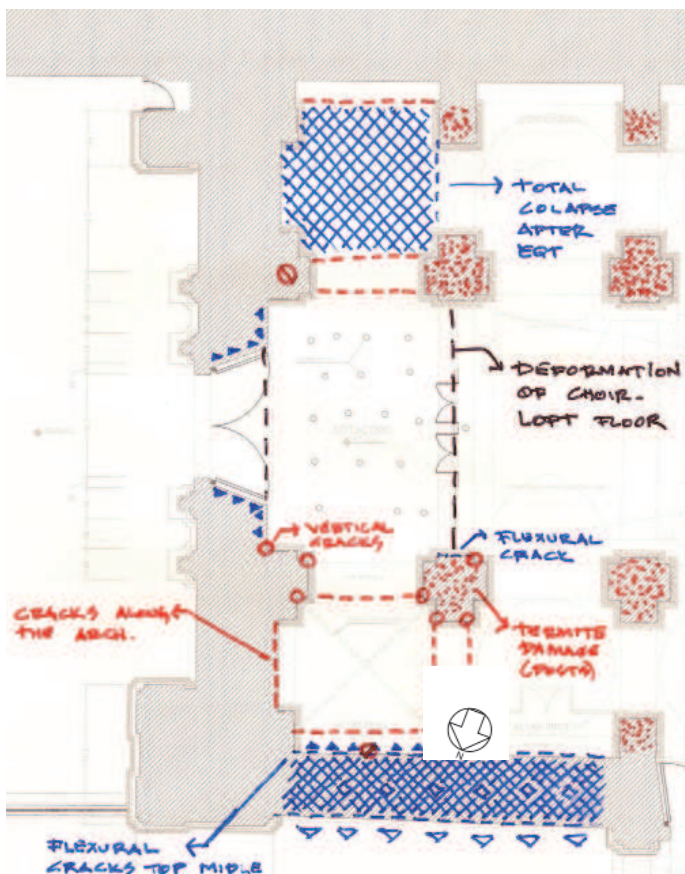

FIGURE 4.42
Sotacoro: Graphic condition survey.
Drawing: Claudia Cancino.



FIGURE 4.43 (TOP)
View of sotacoro, looking south and showing the intact rib-vaulted ceiling above altarpiece K, 2007.
Image: Instituto Nacional de Cultura del Perú.

FIGURE 4.44 (BOTTOM)
View of roof and ceiling above altarpiece K, after collapse, 2010.
Image: Sara Lardinois.

4.6.3 Sector B: South side aisle, adjacent to the former Jesuit college (Fig. 4.45)

- Humidity in the soil and in the remains of the fired brick catacombs below the church floor (as observed in prospection IS-2). This humidity may be the result of improper site drainage in the cloister of the adjacent former Jesuit college. This moisture has led to plaster detachment and disintegration of the masonry in the wall and base course—most noticeably in lower east end of the south lateral wall. This humidity has also resulted in disaggregation of the mortar in the stone foundations, but not to the degree that stones are loose.
- Bricks at the pier bases do not interlock with the brick base course along the lateral wall. The lack of connection is thought to explain the vertical cracking that was observed between the pilasters and lateral walls.
- Out-of-plane displacement of the arches at the pillar wall between the side aisle and nave.
- Partial collapse of the arches attached to the south mud brick wall in the confessional and altarpiece H spaces (Figs. 4.46–4.48).
- Horizontal cracking along the south mud brick wall.
- Minor out-of-plane displacement of the pillar wall, towards the south side aisle.
- Structural disconnection between the pillars and their bases and between the pillars and the arches above.
- Vertical cracking at the west pillar in altarpiece D space.

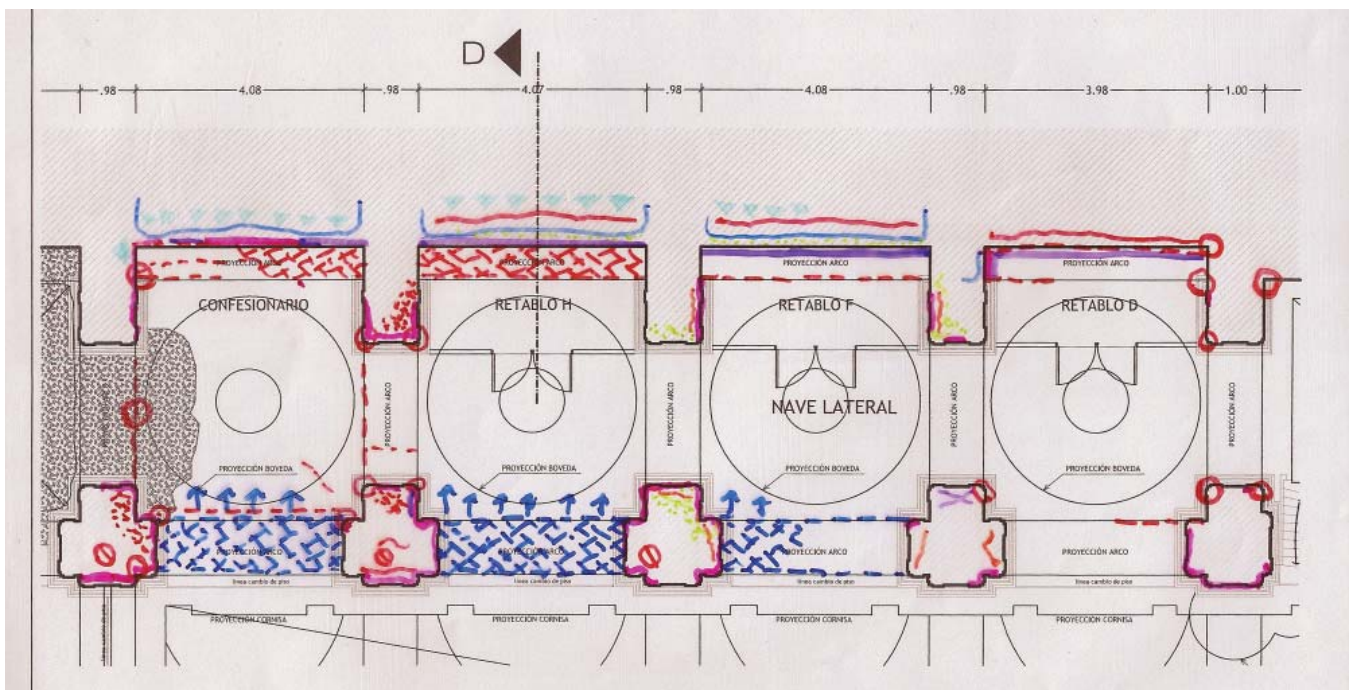

FIGURE 4.45

Sector B: South side aisle graphic condition survey. The dark blue hatch pattern and small dark blue arrows show the out-of-plane displacement at the arches between the side aisle and nave; the large, light blue arrows show areas of moisture damage; the red lines show areas of horizontal cracking; and the red circles show areas of vertical cracking.

Drawing: Claudia Cancino.

FIGURE 4.46 (LEFT)
Sector B: Cracking and partial collapse at arches at the top of the wall, confessional space, 2007.
Image: Philippe Garnier.



FIGURE 4.47 (RIGHT)
Sector B: Cracking and partial collapse at arches at the top of the wall, altarpiece H space, 2007.
Image: Philippe Garnier.



FIGURE 4.48
Sector B: Detail of cracking and partial collapse at arches along the south lateral wall.
Image: Sara Lardinois.

4.6.4 Sector C: Central nave (Fig. 4.49)

- Partial collapse of the central portion of the barrel vault, between the 3" × 10" (0.08 × 0.25 m) wood beams at the tops of the lunettes, in the three bays at the east end of the nave (Fig. 4.50). Based upon the GCI's photographic records from November 2007, the central portion of eastern-most nave vault collapsed several months after the August 2007 earthquake, as photos taken in November 2007 show the vault intact but with cracking in the area that would later collapse. Heavy termite damage to the wood members and corrosion of the connecting nails is thought to have contributed to this collapse (Fig. 4.51). During the 2007 earthquake, the rocking of the pillars added tension to the already deteriorated wood vault arches, breaking them into pieces and leading to failure of the mortise-and-tenon joints. The lateral wood beam at the tops of the lunettes that runs perpendicular to the principal arches may have prevented total collapse of the barrel vault in these bays (Fig. 4.52).

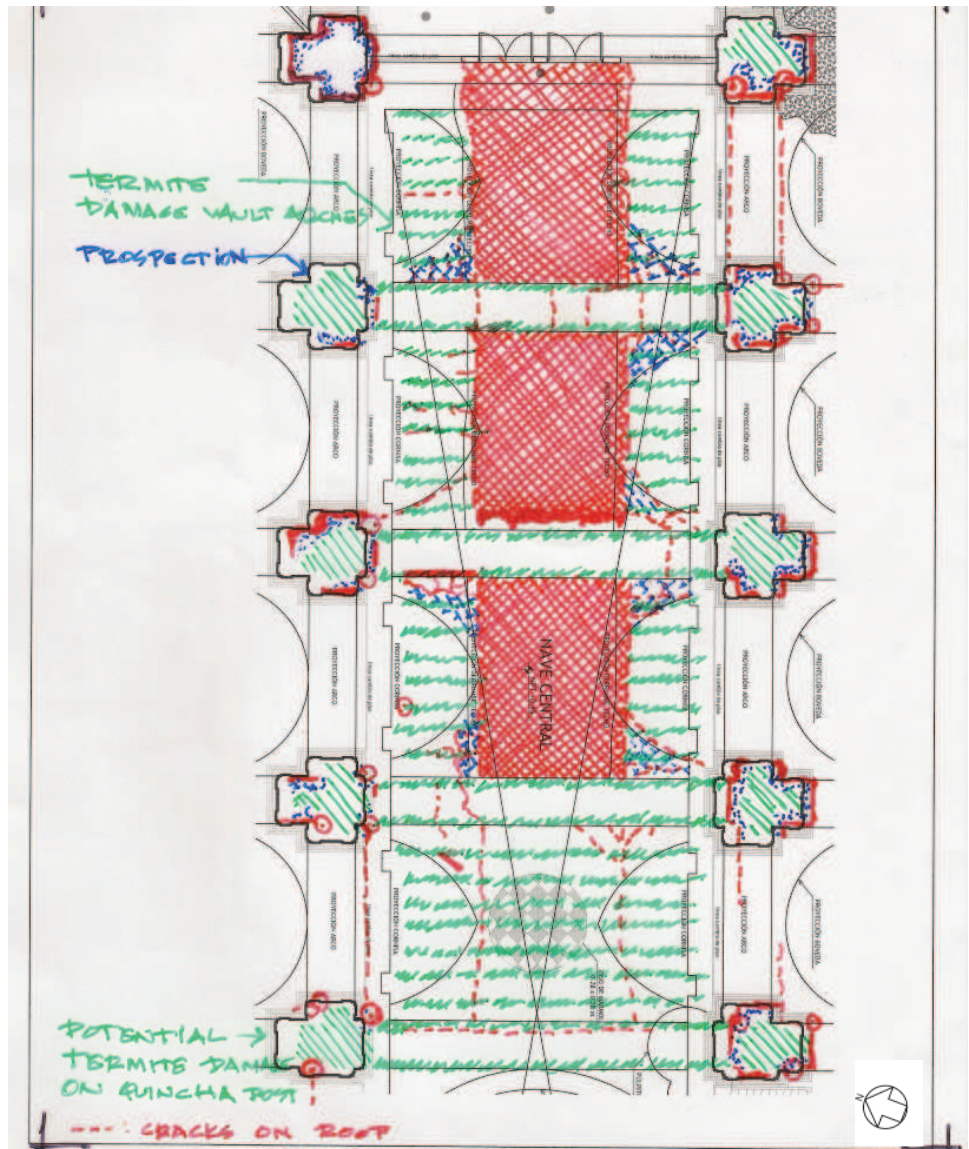

FIGURE 4.49

Sector C: Graphic condition survey. Collapsed portions of the barrel vault are shown in the red hatch pattern.

Drawing: Claudia Cancino.

- All of the pillars are in poor condition, showing signs of structural deterioration. The wood posts, diagonal reinforcements, and sill plate exhibit heavy termite damage and rot from rising damp in the brick bases below (Fig. 4.53). The connections between the posts and the wood arches in the upper part appear to be in fair condition, but some termite damage is present. Most of the plaster exhibits vertical cracking and detachment; and, in areas where the plaster has been lost, the wood elements are exposed to further deterioration. The only element of the pillars that remains in good condition is the huarango tree trunk, which probably helped to prevent collapse of the structure during the 2007 earthquake.
- Minor outward out-of-plane displacement of pillar walls.
- Vertical cracking along the lunettes in all bays.



FIGURE 4.50
Sector C: View of a collapsed bay of the nave barrel vault.
Image: Sara Lardinois.



FIGURE 4.51 (TOP)
Sector C: Damage to wood arches forming the nave barrel vault, with corrosion at the nails connecting the arch segments.
Image: Claudia Cancino.

FIGURE 4.52 (BOTTOM)
Sector C: Top of nave lunette, where the wood beam spanning between the nave arches may have prevented total collapse of the vault.
Image: Claudia Cancino.



FIGURE 4.53 (NEAR RIGHT)
Sector C: View of pillar base, showing deterioration of the wood post and sill.
Image: Sara Lardinois.



FIGURE 4.54 (FAR RIGHT)
Sector D: Cracking in west pillar at the north side aisle.
Image: Claudia Cancino

4.6.5 Sector D: North side aisle, adjacent to Jirón Cajamarca

- Partial collapse of the arch adjacent to the north lateral wall in the altarpiece I space.
- Horizontal cracking at the upper and lower levels of the north lateral wall in all altarpiece spaces.
- Minor inward out-of-plane displacement of the pillar wall.
- Vertical cracks at the west piers of altarpiece E space (Fig. 4.54).

4.6.6 Sector E: Crossing and transept (Fig. 4.55)

- Partial collapse of the southeast section of the umbrella dome over the crossing (Figs. 4.56, 4.57). Termite damage to the wood elements is thought to have contributed to this collapse; however, the circular rings running parallel to the base of the dome and interwoven with the wood ribs, as well as the strong connection between the collar ring and wood frame at the base of the dome, provided strength for the dome structure which ultimately kept it in place.
- Cracking parallel to the dome ribs in the remaining portions of the dome.
- Vertical cracking at the dome pendentives (Fig. 4.58).
- Cracking and disconnection between the transept and the two altarpiece spaces.
- Horizontal cracking at the lower portions of the north and south end walls in the transept.

FIGURE 4.55

Sector E: Graphic condition survey. The combination of the dark blue hatch pattern and small dark blue arrows show out-of-plane displacement; the smaller dark blue hatch pattern alone shows areas of collapse at the main dome; the red lines show areas of horizontal cracking; and the red circles show areas of vertical cracking. Drawing: Claudia Cancino.

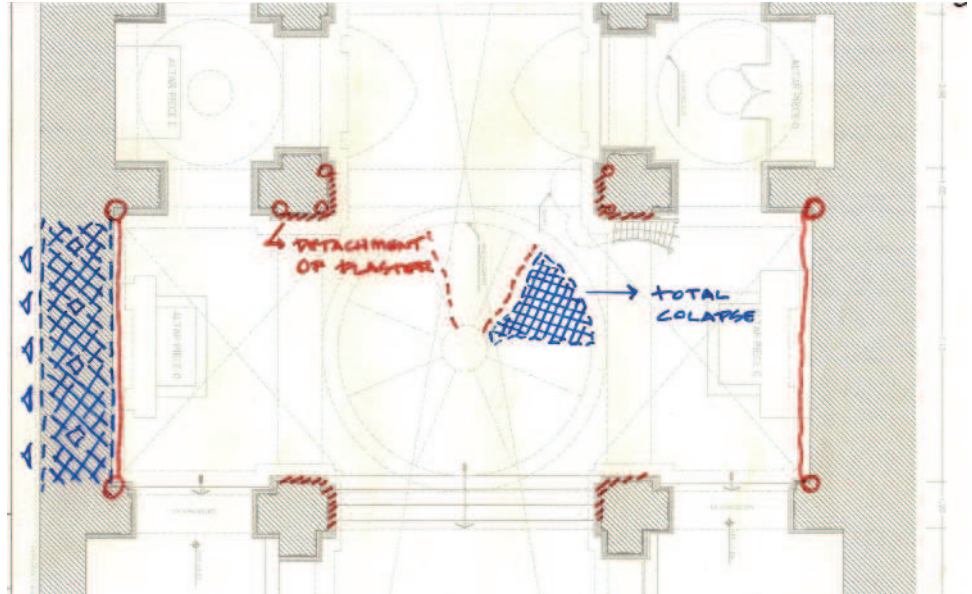

FIGURE 4.56

Sector E: View of partial collapse of quincha dome.
Image: Mirna Soto, for the GCI.



FIGURE 4.57

Sector E: Interior view, looking east, showing the partial collapse of the dome and barrel vault.
Image: Sara Lardinois.



FIGURE 4.58

Sector E: View of the vertical cracks in a pendentive at the main dome.
Image: Claudia Cancino.



FIGURE 4.59
Sector F: The upper west wall behind the altar exhibits out-of-plane displacement and cracking.
Image: Sara Lardinois.



FIGURE 4.60
Sector F: View of vertical cracking in either corner at west wall of the north side chapel, behind altarpiece B.
Image: Sara Lardinois.

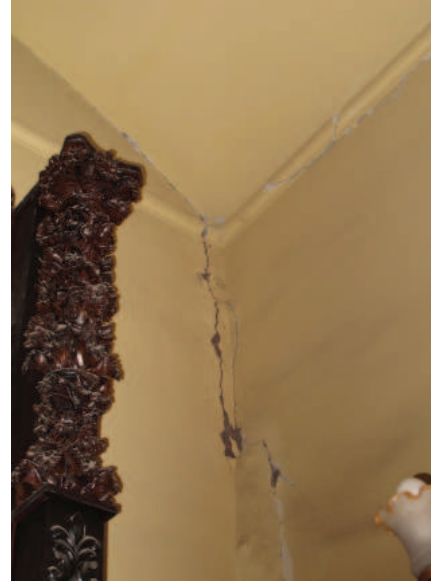

FIGURE 4.61
Sector F: Detail of vertical crack at north-west corner of the cathedral.
Image: Sara Lardinois.

4.6.7 Sector F: Altar

- Outward out-of-plane displacement, disconnection, and cracking at the upper levels of the west end of the altar and the south side chapel, altarpiece A space (Fig. 4.59).
- Cracking parallel to the direction of the vaults in the vaults covering the altar and the side chapel spaces.
- Vertical cracking at the corners of both side chapels (altarpiece A and B spaces) and at the west wall of the altar (Figs. 4.60, 4.61).
- Horizontal cracking at the upper levels of the north and south walls of the altar, as well as at the south and west walls of the altarpiece A space.

4.7 Preliminary Findings

The following preliminary findings on the structural behavior of the church are based upon qualitative methods, including historical research and direct observations made by the investigative team during surveys carried out in 2010. The investigative team utilized their past experience with historic earthen construction to interpret that data collected through research and observation and develop preliminary ideas on the possible structural behavior of the church. These preliminary findings will be explored further in the next phases of the project through quantitative methods, including static and dynamic testing and numerical modeling analyses. Following the quantitative testing and analyses, the preliminary findings will be revised as necessary and expanded upon to provide a complete diagnosis and safety evaluation.

The preliminary findings are:

- The structural performance of the church during the 2007 earthquake can be considered acceptable. The thick longitudinal walls are stable and not prone to lateral overturning. Because these walls maintain their vertical stability during strong earthquake motions, the wood structure at the interior also maintains its lateral stability.
- During the earthquake, elements of the structural system were deformed by the rocking motion and interaction between different elements. When the motion stopped, the elements did not return to their original positions because the timber connections are not rigid and did not behave elastically.
- The roof structure is a 3D linear element system covered in the intrados and extrados with plaster. Therefore, the cracking observed at the internal surface is superficial—only occurring in the plaster layer—and does not necessarily compromise the structural elements. The cracking was generated by rocking and the interaction between the roof and the walls.
- The main cause of collapse of the roof structure appears to be the heavy deterioration of the timber elements, especially at the connections.
- Horizontal cracks in the mud brick walls were caused by lateral vibrations during the earthquake, but they do not reduce the walls' stability and resistance.
- The slender pediment at brick façade is vulnerable to outwards overturning.

Notes

- 1 The information in the following section is summarized from a 2010 report on the history of the Cathedral of Ica, prepared by Deolinda Mercedes Villa Esteves, historian at the former Instituto Nacional de Cultura in Lima, Peru.
- 2 Vargas Ugarte 1963, 103–105. According to Father Rubén Vargas Ugarte, a Jesuit historian, the former Jesuit church in Ica was one of the last buildings constructed by the Jesuits in the region before their expulsion from Peru in 1767.
- 3 Mendicant orders, such as San Juan de Dios, San Camilo de Lelis, and a religious order created in Guatemala—Los Betlemitas—arrived later to establish hospitals.
- 4 For the young nobility of the indigenous population in Peru, the most important colleges were the Colegio Máximo de San Pablo and Colegio Real de San Martín, both in Lima, and Colegio San Francisco de Borja o Colegio de Nobles in Cusco.
- 5 Negro 2001. In the eighteenth century, Jesuits built houses and churches at their rural farms.
- 6 Lecca and Piaget 1974.
- 7 The first Jesuit presence in the region was in Pisco. Between 1704 and 1725, they built a church in Pisco, which later collapsed during the 2007 Pisco earthquake and was subsequently demolished.
- 8 Harth-Terré 2003, 453.
- 9 Vargas Ugarte 1963, 9–13.

- 10 Despite the fact that Jesuits did not require a choir loft for prayer, choir lofts are present over the main entrances in some rural Jesuit churches, reflecting the importance of music in the evangelization in the Peruvian countryside. Choir lofts can be seen in rural Jesuit churches in Lima (San Juan Grande in Surco, San Juan Bautista in Villa) and in Nazca (San José and San Javier). In some cases, choir lofts were added by the religious orders that took over the churches after the expulsion of the Jesuits in 1767. For example, the choir loft at the main Jesuit church in Lima was added by the Oratorians of Saint Philip Neri (Villacorta Santamato 1987).
- 11 Mitma and Alva 2005.
- 12 Seismic zones are defined in Capítulo II, Parámetros de Sitio of the *Norma Técnica de Edificación E.030: Diseño Sismorresistente*, which is available online at http://www.igp.gob.pe/web_page/images/documents/ltorres/norma_tecnica_edificaciones.pdf.
- 13 Information on earthquake dates, epicenter locations, and moment magnitudes (Mw) is summarized from United States Geological Survey (USGS), Historic World Earthquakes, Peru, http://earthquake.usgs.gov/earthquakes/world/historical_country.php#peru.
- 14 Criteria for determining slenderness ratios are based upon those provided in Tolles, Kimbro, Webster, and Ginell 2000.
- 15 *Caña chancada* is the term typically used in the region to describe flattened cane reeds coming from Guayaquil bamboo. The bamboo reeds are 4" (0.102 m) in diameter, with hollow centers.
- 16 *Caña brava* is the term typically used in the region to describe 1" (25 mm) diameter cane reeds with filled centers.

CHAPTER 5

Church of Kuño Tambo

5.1 Summary

The Church of Santiago Apóstol—henceforth referred to as the Church of Kuño Tambo—is the most prominent building in Comunidad Campesina Kuño Tambo, a remote village of 500 inhabitants located southeast of the city of Cusco in the province of Acomayo (Fig. 5.1). Owned by the Roman Catholic Archdiocese of Cusco, the church has been in continuous use as a place of worship since its original construction in the seventeenth century, serving a modest agrarian community. Constructed with thick mud brick walls and buttresses over a rubble stone masonry base course and a wood-framed gable roof, the 500 m² church exhibits many of the design features and materials typical of rural churches in the region (Fig. 5.2). The entire church appears to have been constructed at the same time. Although it has been subject to alterations and decay, it appears to have largely retained its original floor plan and mass, as well as many of its original materials. The structure is in fair condition overall. The preliminary findings indicate that the structural performance of the building is compromised by a leaking roof, inadequate or broken connections at the roof framing, the loss of several exterior buttresses, and settlement of the foundations due to the erosion of the site.

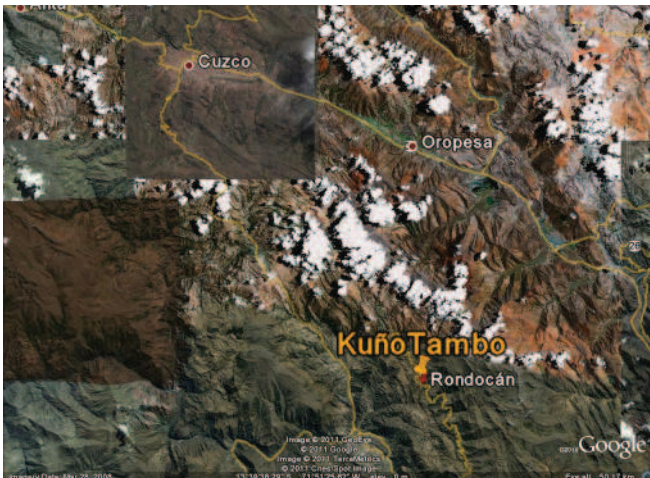

FIGURE 5.1
Satellite image showing the location of Comunidad Campesina Kuño Tambo in relationship to Cusco.
Image: Image © 2011 GeoEye, © 2011 Google, Image © 2011 TerraMetrics, © Cnes/Spot Image.



FIGURE 5.2
Aerial view of the Church of Kuño Tambo, from the southeast.
Image: Wilfredo Carazas, for the GCI.

5.2 Historical Background, Context, and Significance

5.2.1 Historical background and context

The Comunidad Campesina Kuño Tambo is typical of those villages created for the indigenous population in Peru in the sixteenth century under the governance of the Spanish Viceroy Francisco de Toledo.¹ The first reference to the village of Kuño Tambo occurs in a 1577 document on the four *suyos* (regions) of Cusco, where it appears with its earlier name of Cocno and is listed as one of the villages belonging to Condesuyo (one of the four *suyos*).²

When the Spaniards arrived in the New World, they immediately set about trying to organize the indigenous culture in a more political manner. As part of this, they attempted to resettle the indigenous people who had been previously living in small villages or hamlets in new townships called *reducciones*. The name of these new settlements is related to the word *reducir*, meaning “to reduce,” as the idea was to reduce and consolidate the various smaller villages. Each new *reducción* consisted of straight streets and one or two-story houses centered on a main plaza and a church.³ The churches were among the first buildings to be constructed. The Spaniards made several attempts to establish *reducciones* in the Antilles and Mexico,⁴ and they did the same upon arriving in Peru.⁵

In 1552 the *Primer Concilio Provincial Limense* (First Council of the Archdiocese of Lima) enacted the second of the forty *Constituciones de Los Naturales* (laws governing the Indians), requiring that churches should be established in Indian villages and describing how they should be built. The law also indicated that pieces of art should be included in the churches to express the dignity of those places.⁶ In 1567 the *Segundo Concilio Provincial Limense* (Second Council of the Archdiocese of Lima) set the capacity of the churches at 400 “tributaries,”⁷ which according to Reverend Father José Acosta, *Societatis Iesu* (1540–1600), meant nearly 1,500 people.⁸

Churches were typically built with their front façades facing the main plaza; however, they were sometimes built over old temples, which may not have had any relationship to the new plaza.⁹ This probably explains why the Church of Kuño Tambo does not face the village's main plaza, Plaza de Armas.¹⁰ Churches typically included an *atrio* (walled forecourt), *sotacoro* (the area under the choir loft), choir loft, single nave, presbytery with altar, sacristy, storage for ecclesiastical furniture such as stands, and a cemetery. In front of the church there would be a *cruz de caminos* (cross), and, in the Andes, a free-standing bell tower, separate from the church.¹¹

According to documents in the parish archive of Acomayo, the Church of Kuño Tambo was constructed in 1681.¹² Prior to that time, the village of Kuño Tambo was considered an annex to the *doctrina* (rural parish church) of San Juan de Quihuas.¹³ As was typical of the time, the Church of Kuño Tambo owned several properties which were rented out to generate income for maintenance activities.¹⁴ The design of the Church of Kuño Tambo, as described in a 1689 document, followed the typical pattern of churches built in Indian villages:

El Templo Santiago Apóstol conserva una portada principal de dos hojas con arco de medio punto rematados por dos pilares de adobes y con sobrecimientos originales de piedra e interiormente se disponen el sotocoro, coro, baptisterio, nave y sacristía. (The Church of Santiago Apóstol has a main door with two leaves with an arched top with two adobe pilasters and an

original stone foundation. Inside the church there is a sotacoro, choir loft, baptistery, nave, and sacristy.)¹⁵

Mural paintings were also noted at that time:

El anexo de Cunutambo ubicado a una legua del pueblo grande de Rontocan, revestido interiormente de pintura mural, cuenta con pocos ornamentos y tiene cofradías consagradas a Santiago Apóstol, Virgen Rosario y Virgen Purificada del que se sustenta la Iglesia y tiene cien almas de confesión . . . (Cunotambo Annex is located one league from the large village of Rontocan; it has mural paintings inside and it has very few ornaments; there are three brotherhoods—Santiago Apóstol, Our Lady of the Rosary and the Immaculate Conception—who contribute to the maintenance of the church; and it has 100 parishioners . . .)¹⁶

An inventory prepared in 1767 included a long list of liturgical objects, such as chalices and crosses.¹⁷ In the first half of nineteenth century, a new inventory was undertaken, which noted the existence of the following paintings at the main altarpiece: *The Virgin Mary and Child with Angels* and *Saint Dominique Receiving the Rosary from Our Lady*. Sculptures included *Nuestra Señora del Rosario*, *San Cristóbal*, *Virgen Purificada*, *Santa Rosa de Lima*, *San Isidro Labrador*, *Santa Epifania*, *Señor de la Vara*, and *Inmaculada Concepción*. Books and liturgical objects made of silver and other materials were also reported at that time.¹⁸

During the investigations carried out as part of the construction assessment in July 2010, human bones were found beneath the floor level in the southwest corner of the church.

5.2.2 Significance

Although not formally registered as a national monument at the time of the preparation of this report, the Church of Kuño Tambo is valued as a significant building by the community it serves. This was evident during the construction assessment field campaigns, with community members demonstrating interest in the research process, meeting with the project team members on several occasions, and expressing a desire to restore the church. The research carried out as part of this construction assessment has led the Cusco regional office of the Ministerio de Cultura del Perú to begin the process of nominating the church, as well as the entire town, as a national monument due to its originality, authenticity, and preservation of earthen structures and construction techniques.

5.3 Architectural Description

High in the Andes at an approximate elevation of 3,365 m, the village of Kuño Tambo is situated in a shallow valley surrounded by agricultural lands. A narrow and winding road running through the center of the valley connects Kuño Tambo to Cusco and the nearby village of Rondocán. The village consists primarily of vernacular earthen residential and agricultural buildings, constructed on the sloping land flanking either side of the road. The centerpiece of the village is the formal Plaza de Armas, which is bordered by several small civic and residential buildings. The Church of Kuño Tambo is sited to the northwest of the plaza and to the north of main road (Fig. 5.3). The primary façade of the church faces south and addresses the road, rather than the plaza.

The church is built over a natural rock outcropping on the northern slope of the village. The site generally slopes downward 2–3 m from the north to south end of the building and also slopes away from the east and west sides of the building. The church is largely a free-standing structure. Earthen site walls enclosing a farm or storage yard abut the north wall of the church; however, these site walls are not structurally connected to the church itself. The landscape immediately surrounding the church consists of vegetated native ground cover, bare soil, and exposed rock.

The one-storey, 500 m² Church of Kuño Tambo consists of a large rectangular mass (described as the “main church” in this report) oriented along a North–South axis and two smaller wings housing a baptistery and sacristy located along the east lateral wall of the main church (Fig. 5.4). The main church has simple rectangular floor plan with a 1:4 proportion, measuring 7.75 × 31.00 m at the interior, and is covered by a single gable roof. The main church is essentially a single room containing five different functional spaces: a sotacoro, choir loft, nave, presbytery, and altar. Changes in floor level, railings, and interior pilasters are used to separate the different spaces (Fig. 5.5). The church is accessed through a large pair of doors at the south gable wall, and the altar is located at the far north end of the building. The



FIGURE 5.3
Aerial view of the village of Kuño Tambo, showing the location of the main road, the Plaza de Armas, the church, and its free-standing bell tower.
Image: Wilfredo Carazas, for the GCI.

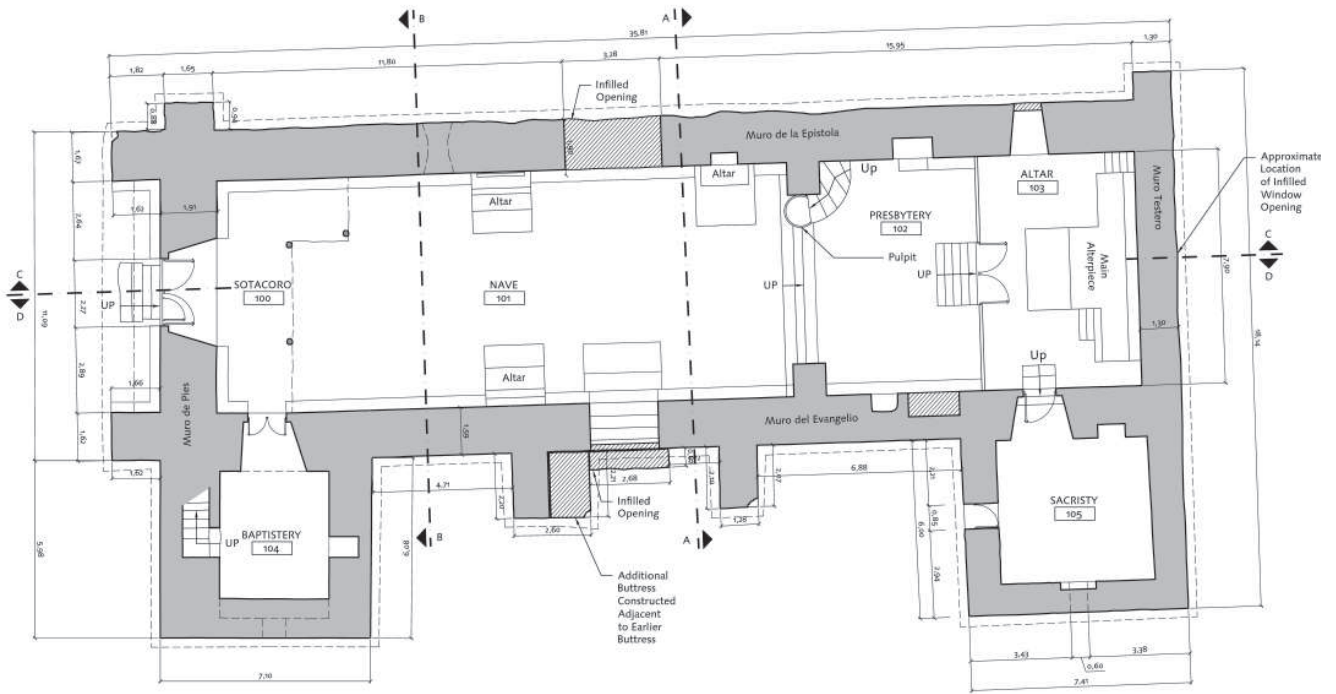

FIGURE 5.4

Floor plan, Church of Kuño Tambo.

Drawing: Base drawing prepared by Ruben Estrada Tapra and edited by the GCI.

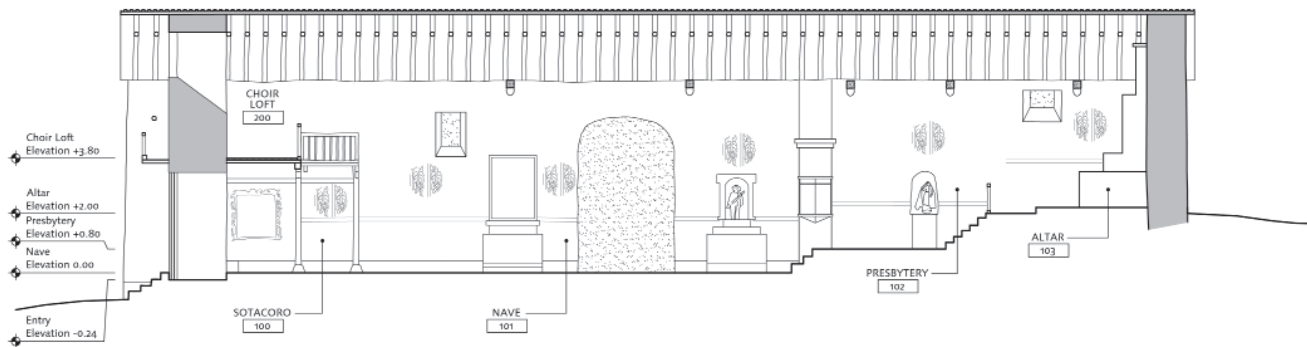

FIGURE 5.5

Cross section C-C, Church of Kuño Tambo.

Drawing: Base drawing prepared by Ruben Estrada Tapra and edited by the GCI.

6 × 7 m baptistery and 6 × 7.5 m sacristy wings each have a nearly square-shaped plan and separate gable roofs that run perpendicular to the main roof. The baptistery is located in the southern-most wing, immediately adjacent to the main entry and sotacoro. A narrow staircase, cut into the adobe wall at the south side of the baptistery, provides access to the wood-framed choir loft above the sotacoro and an exterior balcony spanning across the south gable wall of the main church. The entire church appears to have been constructed at the same time, which is corroborated by historic documents.

The exterior appearance of the church is largely defined by its planar wall surfaces and the form of its gable roofs. The south gable wall is the primary façade and, thus, is more highly articulated than the other façades (Fig. 5.6). It is symmetrical in design, with two large earthen buttresses framing the arched opening at the entry door and wood-framed balcony above. A niche containing a religious statue and a rectangular opening are set in the center of the upper gable wall. Only the door opening providing access to the east end of the balcony breaks the symmetry. The other façades are less articulated, with long spans of uninterrupted wall planes. Several buttresses break up the long lateral walls and small openings occasionally punctuate the upper portions of the walls. Exterior materials include the exposed stone base course, plastered and exposed mud brick walls, and a terra cotta tile roof. The roof system, including the tie beams, wood collar ties and rafters, canes, and a mud and straw layer, is exposed at the underside of the eaves.

The interior walls are more highly articulated than the exterior walls, with low, plastered mud brick banquettes at the base of the walls, earthen bases for the altar pieces along the lateral walls, and numerous small niches cut into the wall thickness. Interior finishes include fired brick floor pavers, plastered mud brick walls, and exposed wood roof framing (Fig. 5.7). The plaster at the east, south, and west walls of the main church is decoratively painted with geometric and figurative motifs (Fig. 5.8), while other plastered areas are painted white. Wood is used for the choir loft construction (Fig. 5.9), doors, and railings separating the nave, presbytery, and altar. Interior furnishings include a monumental wood altarpiece at the



FIGURE 5.6
Primary façade at south side of church, with the baptistery wing to the right.
Image: Sara Lardinois.



FIGURE 5.7
View of interior, from nave looking towards the presbytery and altar.
Image: Claudia Cancino.

north wall (Fig. 5.10), smaller altar pieces along the lateral walls, and a wood pulpit.

The church is part of a larger religious complex, which includes a free-standing earthen bell tower to the south (Fig. 5.11). The church and bell tower are currently separated by the main road running through the village. It is likely that they were originally connected by a church yard; but, if such a yard once existed, it was lost by the later development of the road and construction of various small buildings between the two structures. The bell tower is not part of this construction assessment.

FIGURE 5.8 (LEFT)

Wall paintings at southwest corner of the sotacoro.

Image: Amila Ferron.



FIGURE 5.9 (RIGHT)

View of choir loft and sotacoro, from nave.

Image: Sara Lardinois.



FIGURE 5.10 (LEFT)

Monumental altar piece.

Image: Wilfredo Carazas, for the GCI.



FIGURE 5.11 (RIGHT)

Free-standing bell tower to the south of the church.

Image: Sara Lardinois.





FIGURE 5.12
View of erosion at east side of church.
Image: Mirna Soto, for the GCI.

5.4 Geological and Environmental Description

5.4.1 Geological description and seismic history

The church (lat 13°39'38" S; long 71°51'26" W) is built on a natural rock outcropping, with some compacted clay fill used to level the site. Thus, depending on the topography, the foundation either bears directly on the rocky soil or the compacted clay fill. As a result of the steep topography and use of clay fill, some portions of the interior finish floor are significantly higher than the adjacent exterior grade level. The most extreme differential is at the east side of the church, where the interior floor elevation is approximately 2 m higher than the adjacent grade and large portions of the natural rock outcropping are visible below the base course. The visible outcropping in this area shows signs of sedimentary rock erosion (Fig. 5.12). This erosion may be the result of improper site drainage, which is made worse by the natural slope of the site; however, the water source(s) contributing to the erosion were not immediately clear, as the construction assessment survey was carried out during the dry season. Possible drainage sources include surface water runoff from the upper village, falling water from the roof eaves, or a combination of those two factors. Alternatively, this erosion may be the result of excavations carried out in the past.

The building is located in a level 2 seismic risk zone, as classified by the Peruvian Building Code, which is the middle level on a scale of 1 to 3.¹⁹ As the church was constructed in the seventeenth century, it has been subject to a number of seismic events throughout its history, including the 1950 Cusco earthquake (M_w 6.0), approximately 35 km to the northwest; the 1943 Yanaoca earthquake, approximately 65 km to the southeast; and 1913 Abancay earthquake, approximately 120 km to the west. It is possible that the church was also subject to the 1746 Lima and 1687 Lima (M_w 8.5) earthquakes, approximately 600 km to the northwest.^{20 21}

5.4.2 Regional climate

The weather station in Cusco, approximately 35 km northwest of the village of Kuño Tambo, reports the annual average maximum temperature is 22°C and the average minimum is 3° C; however, in the winter, lows may drop below 0°C. As measured since 1976, the maximum average annual rainfall is 1125 mm and the minimum is 460 mm. It rains over 100 days each year.

5.5 Structural Description

The following sections describe the different structural materials, elements, and systems making up the Church of Kuño Tambo (Fig. 5.13). Their current condition and any irregularities, alterations, damages, and decay observed during the construction assessment survey are described in greater detail in section 5.6 that follows the structural description.

5.5.1 Survey sectors

For the purpose of conducting the construction assessment survey, the church was divided into five sectors (Fig. 5.14). All five sectors appear to have been constructed at approximately the same time and exhibit similar construction materials and techniques. The sectors were selected based upon the architectural configuration, considering differences in the floor plan, height, and connection details. The sectors are as follows:

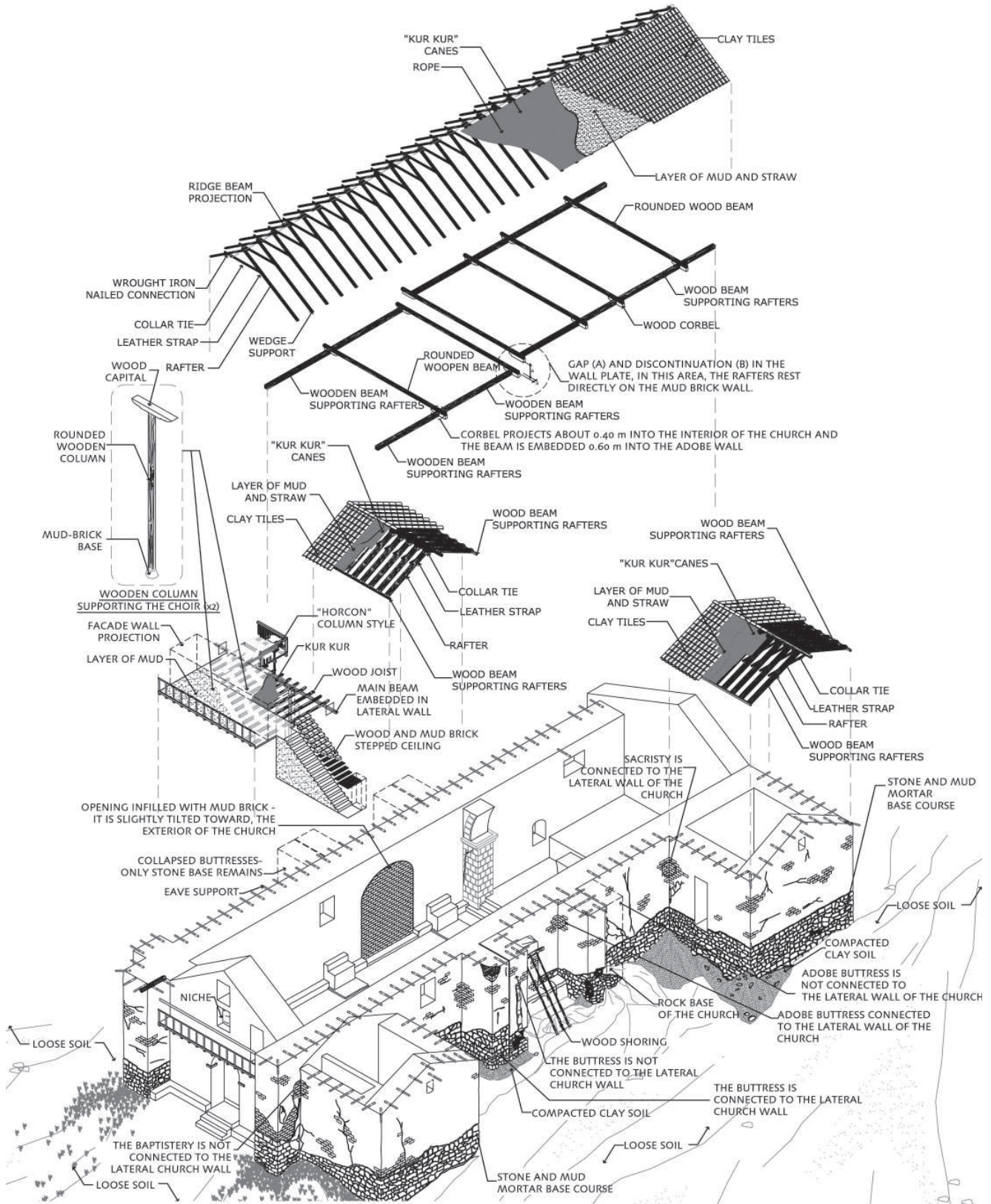

FIGURE 5.13
Overall structural scheme for the church.
Drawing: Mirna Soto, for the GCI.

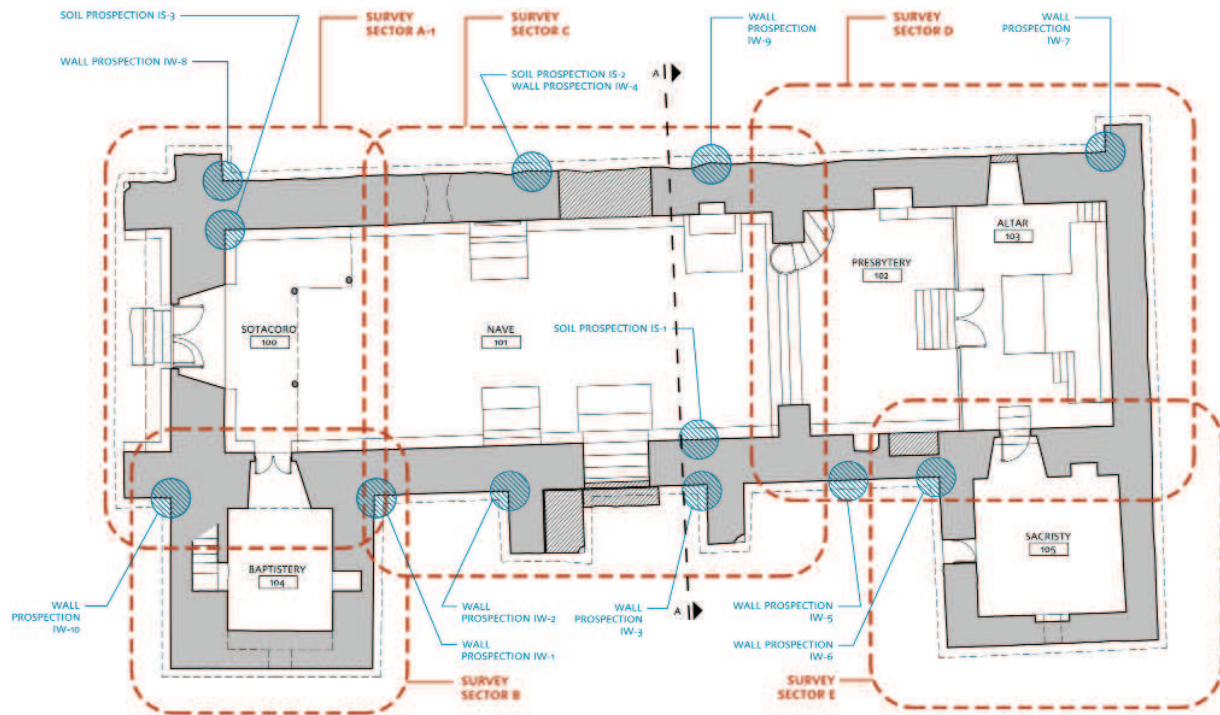

FIGURE 5.14

Floor plan, showing sector and prospection locations.

Drawing: Base drawing prepared by Ruben Estrada Tapra and edited by the GCI.



- **Sectors A-1 and A-2:** The far south end of the main church, encompassing the sotacoro (sector A-1) and the choir loft above (sector A-2).
- **Sector B:** The low baptistry immediately adjacent to the east wall of the sotacoro.
- **Sector C:** The tall, 6.5 m high, rectangular nave, situated in the center of the main church.
- **Sector D:** The presbytery and altar, separated from the nave by two earthen piers and a change in floor level.
- **Sector E:** The sacristy, immediately adjacent to the east wall of the altar.

5.5.2 Foundations and base course

The building foundation and base course are comprised of a stone base course bearing directly on the rocky soil or compacted clay fill. The base course is constructed of rubble stone masonry with a mud mortar. The stones vary in size, with some stones exceeding 0.64 m in width, while the mortar joints vary in width from 20 to 60 mm. The width of the base course matches the width of the mud brick wall above. The base course typically varies in height from 1.20 to 1.50 m, following the natural slope of the site; however, it appears to be taller at the southeast corner of the baptistry and along the east elevation of the nave. The relationship also varies between the bottom of the base course and the interior floor level and current exterior grade level. In some locations, the bottom of the base course extends below both the interior floor level and the exterior grade (Fig. 5.15). At other locations, primarily at the east wall, the bottom of the base course is higher than both the interior floor level and the exterior grade, and the rocky soil or compacted clay fill on which it bears is exposed (Figs. 5.16–5.18).

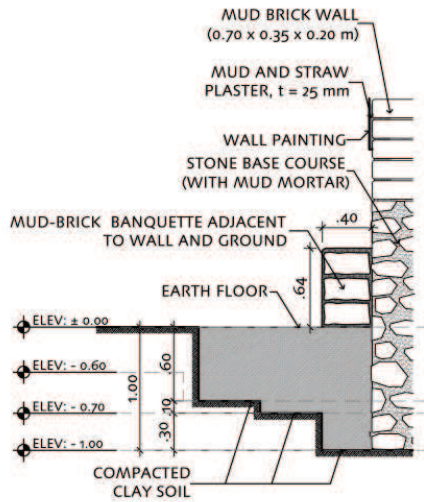

FIGURE 5.15
 Prospection IS-3, section view illustrating the base course at the southwest corner of the main church. Drawing, Mirna Soto, for the GCI.

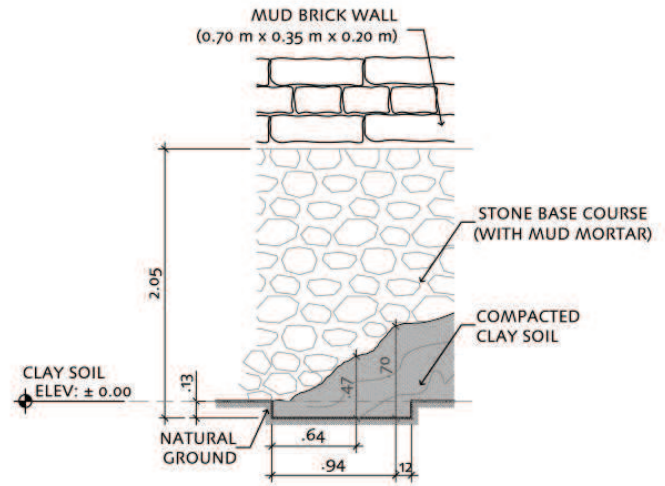

FIGURE 5.16
 Prospection IW-5, exterior elevation view illustrating the base course at the east side of the main church. Drawing: Mirna Soto, for the GCI.

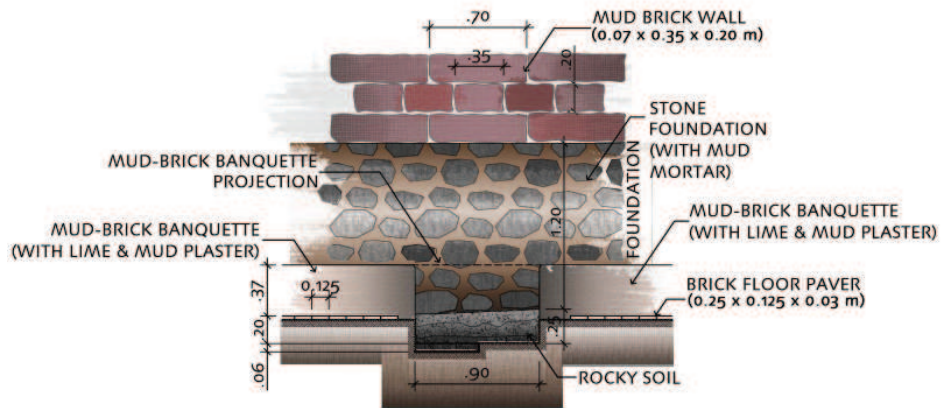

FIGURE 5.17
 Prospection IS-1, interior elevation view illustrating the base course at the east side of the main church. Rendering: Jabdiel Zapata, for the GCI.

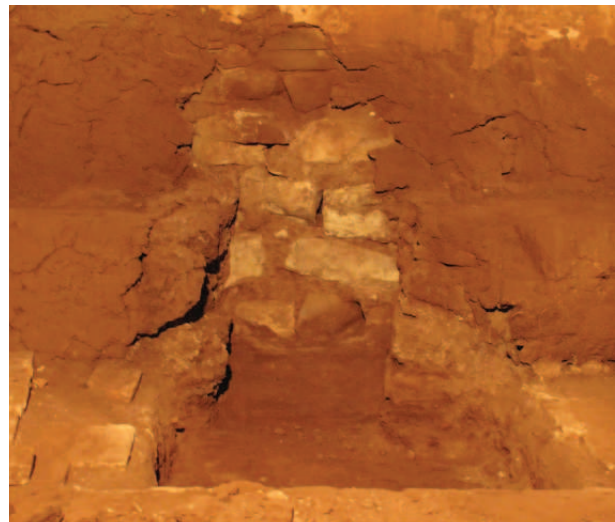

FIGURE 5.18
 Prospection IS-1, photographic view. Image: Claudia Cancino.

5.5.3 Walls

The walls are of load-bearing mud brick construction, with a plaster finish at both the interior and exterior faces. The mud bricks are set in an English bond pattern, with alternating courses of header and stretcher bricks.²² A typical mud brick measures 0.70 m long × 0.35 m wide × 0.20 m high. The mud bricks are made of earth with many small rocks in it, reflecting the soil characteristics of the site, and are reinforced with straw. The bricks are laid in a mud mortar, with both the horizontal and vertical joints having an average thickness of 15 mm. In those portions of the wall that have been affected by wind erosion, the bricks are more deteriorated than the mortar joints, implying a difference in material composition and strength. This may be related to a past repointing effort. In their current condition, the exterior faces of the walls are largely unfinished and the mud bricks are exposed; however, some exterior plaster remains in the upper portion of the south façade, which is sheltered by the roof overhang. The interior finish typically consists of one 20–30 mm thick layer of mud and straw plaster and one layer of 1–2 mm thick painted gypsum; however, where later plaster coats have been applied over the original plaster, the thickness reaches up to 60 mm. Much of the interior wall plaster is decoratively painted.

The main church and baptistery walls vary in thickness from 1.4 to 2 m and range in height from 3 to 6 m at the eaves to 5.5 to 8.5 m at the gable ends, as measured from the visible top of the stone masonry base course. The sacristy walls are somewhat thinner at 1.2 m; and they are approximately 3.8 m high at the eaves and 5.7 m at the gable, as measured from the top of the stone masonry base course. All walls can be classified as thick in relationship to their height, with a slenderness ratio of less than six.²³

A low mud brick banquette is located at the interior face of the east, south, and west walls of the main church. This banquette bears directly on the rocky soil or compacted clay fill; and, it is constructed immediately adjacent, but is not connected, to the mud brick walls.

A large arched opening is set in the center of the south gable-end wall. Similar arched openings were also located in the center of each lateral wall; however, these have since been infilled with mud bricks or altered in other ways (see section 5.6.2 for further description). Other smaller openings are located in the upper portions of both the gable-end and lateral walls, and some of them have also been infilled with mud bricks. Closely-spaced wood lintels are used to span the openings. The ratio of openings to the vertical surface area of the façades is provided in Table 5.1.

Table 5.1: Ratio of openings to total vertical surface area of façades

Façade	Area of Openings*/Total Vertical Surface Area of Façade
Main church, north façade	2.8%
Main church, east façade	4.5%
Main church, south façade	12.5%
Main church, west façade	8.9%
Baptistery, all façades	0.5%
Sacristy, all façades	1.3%
Average of all façade ratios	5.1%

* Includes any infilled openings, such as those at the north, east, and south façades of the main church.

The long lateral walls of the main church are reinforced with full-height mud brick buttresses with stone base courses. One buttress flanks either side of the infilled door opening in the center of the east lateral wall; and, at the south side of that infilled opening, an additional buttress has been constructed immediately adjacent to the north of the original buttress (Figs. 5.19, 5.20). The remaining stone base courses and ghost lines in the walls at the west façade indicate that buttresses flanked either side of the infilled west door at some time in the past (Fig. 5.21). Mud brick buttresses have also been used to reinforce the southeast, southwest, and northwest corners of the church. These corner buttresses are essentially extensions of the walls beyond the intersection of the perpendicular wall planes. In addition to the buttresses, the baptistery and sacristy wings provide additional bracing for the east lateral wall.²⁴

FIGURE 5.19

Axometric view of east lateral wall, illustrating locations of existing and lost buttresses.

Drawing: Mirna Soto, for the GCI.

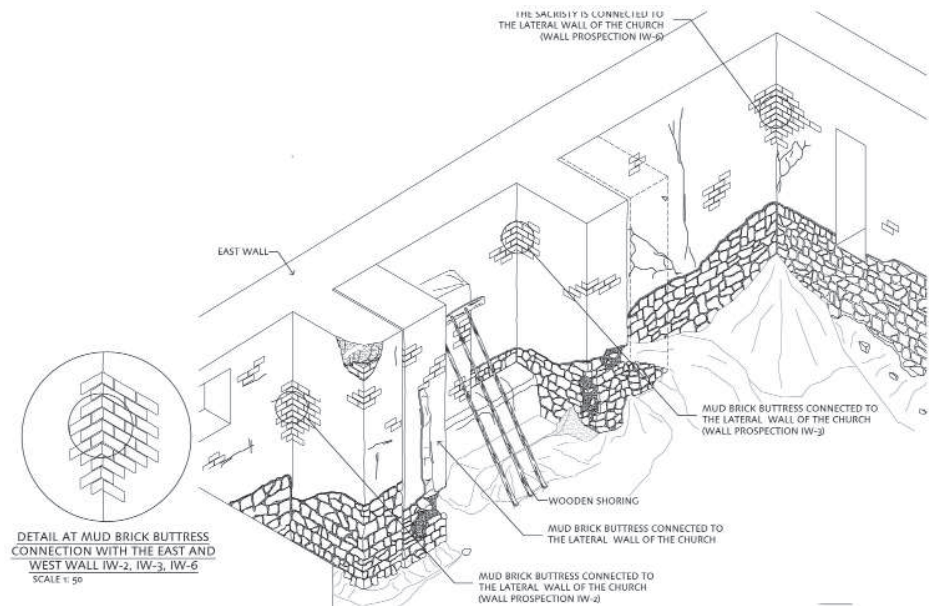

FIGURE 5.20

View of east lateral wall of main church, showing buttresses.

Image: Wilfredo Carazas, for the GCI.



FIGURE 5.21

West lateral wall of main church, showing the infilled opening and collapsed buttresses.

Image: Claudia Cancino.



FIGURE 5.22 (ABOVE)
 Prospection IW-1, detail at the intersection of the baptistery wall (left) and east lateral wall of main church (right).
 Image: Mirna Soto, for the GCI.

FIGURE 5.23 (RIGHT)
 View of the east lateral wall of the church and baptistery wing, illustrating the wall connections.
 Drawing: Mirna Soto, for the GCI.

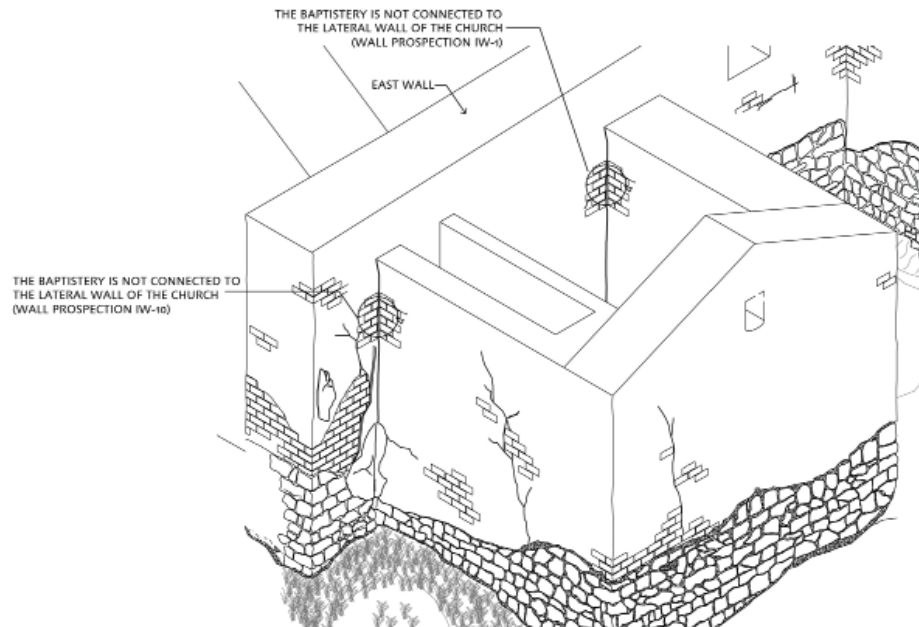

The corners of the mud brick walls are woven together with overlapping bricks. The sacristy walls (sector E) are connected to the lateral wall of the nave through a similar connection; however, there is no connection between the baptistery walls (sector B) and the lateral wall of the nave (Figs. 5.22, 5.23). With the exception of the additional buttress at the east and west façades, all buttresses are connected to the nave walls with overlapping bricks.

5.5.4 Floors

The main floor of the church sits directly on top of the rocky soil or compacted clay fill used to level portions of the site. There are four different levels which correspond to both the natural topography of the site and the functional needs of the church: the nave and baptistery at the lowest elevation; the presbytery; the altar; and the sacristy which is approximately 2.87 m higher than the nave floor. The finish flooring consists of fired brick pavers set in earth over rocky soil or exposed clay fill (Fig. 5.24).

The choir loft floor consists of wood planks over wood joists (Fig. 5.25). The joists supporting the main choir loft floor run in the North–South direction, from the south façade wall to a wood beam. The ends of this wood beam are embedded in the lateral mud brick walls and two sawn wood columns with mud brick bases and decorative wood capitals provide intermediate support for it. Joists running in the East–West direction support the northwest corner of the balcony extension. Both the beam supporting these joists and the column below are unsawn tree trunks, suggesting that this extension is a later addition. The underside of the choir loft floor is finished with a decoratively-painted plaster coat.

The floor of the exterior balcony at the south façade consists of wood planks over wood joists that are cantilevered from the mud brick wall (Fig. 5.26). It is unclear if these joists are simply extensions of the interior choir loft floor framing or if they are separate framing elements.



FIGURE 5.24
 Fired brick floor pavers, as removed for the inspections and numbered for reinstallation.
 Image: Mirna Soto, for the GCI.



FIGURE 5.25

View of the choir loft framing, looking southeast.
Image: Amila Ferron.



FIGURE 5.26

View of the exterior balcony at the south façade.
Image: Claudia Cancino.

5.5.5 Roof

The main church has a single gable roof with an approximate slope of 8:12. The baptistery and sacristy have separate gable roofs of a similar slope; however, they are set perpendicular to the axis of the main church roof. All sections of the roof are constructed with wood *pares y nudillos* framing, which are trusses composed of two rafters joined with a collar tie (Figs. 5.27, 5.28). The rafters are made from 8" (0.20 m) diameter willow tree trunks; and they overlap one another with half-lap joints at their intersection (Fig. 5.29). The rafters are tied to one another and the ridge beam above with leather straps or ropes and wrought iron nails. The collar ties are simply strapped or nailed to the rafters, without a cut wood joint. Above the trusses are *Kur Kur* canes that are woven and tied together with rope,²⁵ a mud and straw layer (*torta de barro*), and Spanish style terra cotta roof tiles.²⁶

The main church roof consists of 47 *pares y nudillos* trusses and six wood tie beams. The ends of the rafters at the main roof are cut at a 90° angle and sit on 0.17 × 0.17 m wood plates embedded in the lateral mud brick walls (Figs. 5.30, 5.31). These wall plates are neither continuous nor tied together. Therefore, the plates do not function as bond beams; rather, their primary function is to support the rafter ends. The transverse tie beams are made from alder, or birch, tree trunks and also have an approximate diameter of 8" (0.20 m). The tie beams sit on wood corbels, and both the beams and corbels extend approximately 0.60 m into the depth of the mud brick wall. In the central portion of the nave, two of the tie beams are closely placed together, almost forming a pair. There is a gap in the wall plate between the two tie beams, and the rafter ends at the south side of the tie beam pair are at a lower vertical elevation (Fig. 5.32). There are not any tie beams at the far south end of the main roof.

Both the baptistery and sacristy roofs consist of six *pares y nudillos* trusses and one bay of rafters without a collar tie. Unlike the main church, the roof rafters in these two sectors appear to sit directly on the mud brick walls, without a wood plate. The wood rafters of the baptistery and sacristy roof are tied with leather straps to wood elements embedded in the upper sections of the east gable walls.²⁷ The baptistery has one tie beam, without corbels, that connects its north and south lateral walls.

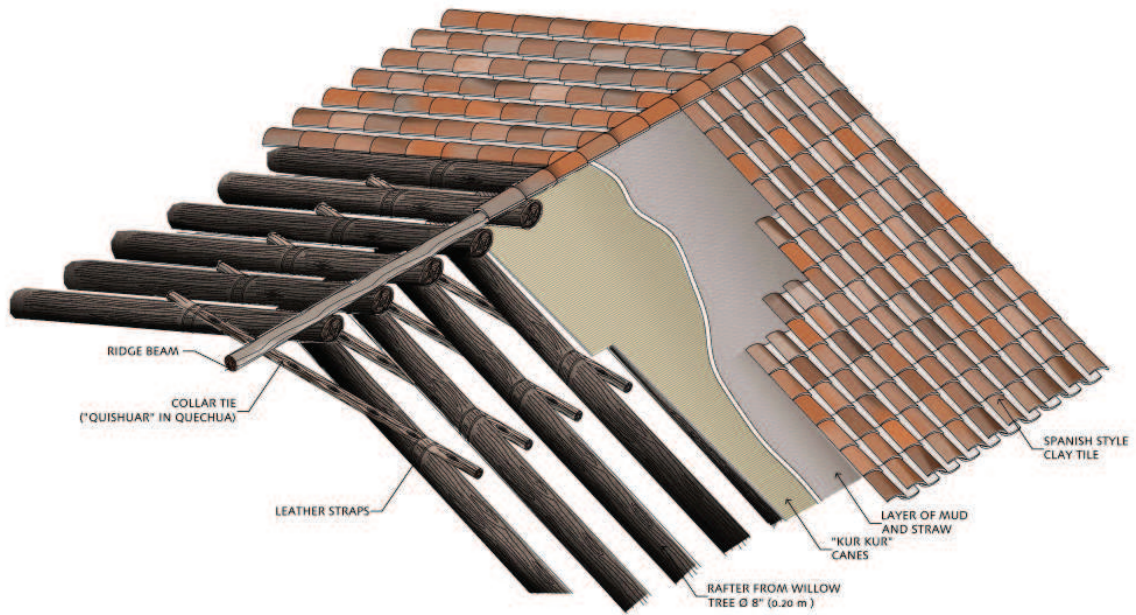

FIGURE 5.27
Detail showing pares y nudillos (rafters and collar ties) framing and roof covering.
Rendering: Jabdiel Zapata, for the GCI.



FIGURE 5.28
View of pares y nudillos framing and tie beams over the nave.
Image: Claudia Cancino.



FIGURE 5.29
Half-lap joint at intersection of roof rafters over main church.
Image: Claudia Cancino.

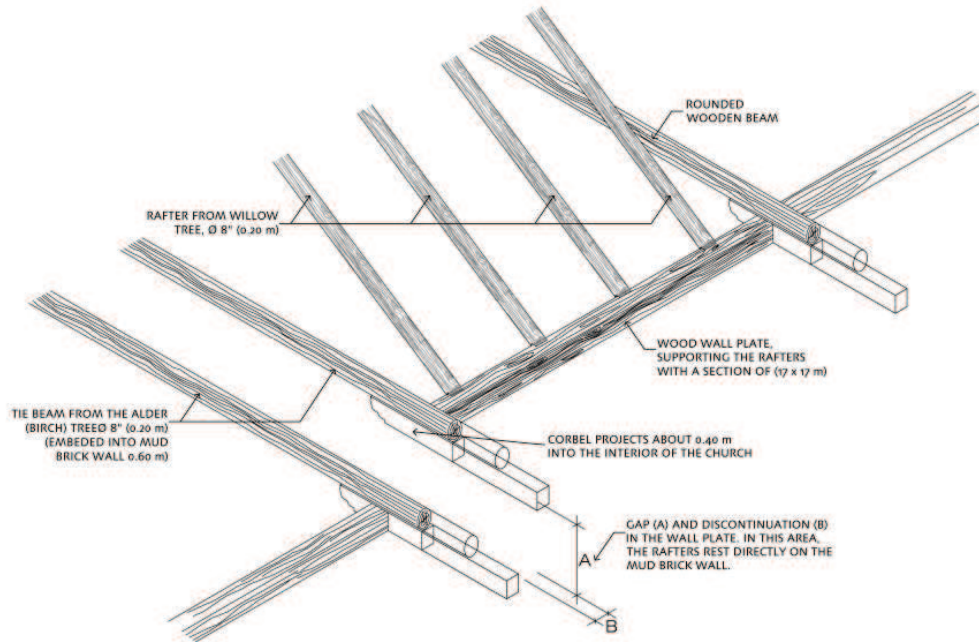

FIGURE 5.30
Prospection IR-2, showing connection between the rafters and wall plate, as well as the tie beam and corbel.
Drawing: Mirna Soto, for the GCI.



FIGURE 5.31
View of rafters and wall plate at the lateral wall of nave.
Image: Claudia Cancino.



FIGURE 5.32
View of the pair of tie beams over the nave.
Image: Mirna Soto, for the GCI.

5.6 Irregularities, Alterations, Damages, and Decay

The following sections describe the current condition of the different structural materials, elements, and systems making up the Church of Kuño Tambo and any irregularities, alterations, damages, and decay that were visually observed during the construction assessment survey.

5.6.1 Foundations and base course

In those sections of the base course that are visible from the exterior or through prospections carried out as part of the survey, the base course was observed to be in fair to good condition. The mortar is generally cohesive; however, in some locations, the stones have become loose. There has been some loss of face stones and mortar at the exterior side of the base course. This deterioration is greatest at the east wall of the church and baptistery. The base course of the north buttress at the east wall has been severely compromised by loss of material at its southeast corner. Improper site drainage, erosion, and/or excavation of the rock outcropping in this area may be contributing to the damage (Figs. 5.33, 5.34).

5.6.2 Walls

The walls have been subject to a number of alterations, most of them related to the door and window openings and the buttresses. Alterations to the door and window openings include:

- The large arched door opening at the west lateral wall has been infilled with mud bricks, which are not structurally connected to the adjacent walls. These mud bricks have not been plastered or painted and thus are visible from the interior (Fig. 5.35).
- The large arched door opening at the east lateral wall was modified to create an interior niche. The interior face of the altered wall is plastered and decoratively painted to match the adjacent interior surfaces, suggesting that this alteration occurred earlier than the one at the west door. The thin mud brick wall at the back of the niche has been reinforced by the construction of a separate mud brick wall at the exterior. This exterior wall is unstable, exhibiting outward displacement, and temporary wood shoring has been installed at the exterior face to prevent further displacement.
- It appears that there was originally a door at the west end of the south façade connecting the choir loft and exterior balcony, mirroring the existing door at the east end of the façade. Any such door appears to have been infilled.
- It appears that the window opening at the north elevation has been partially infilled. Although this window is visible from the exterior, it is obscured from interior view by the main altarpiece. What, if any, infill material was used at inside face of the window opening is unknown.

Alterations to the buttresses include:

- At the west lateral wall, two earthen buttresses flanking either side of the infilled door opening have collapsed or been removed; however, the stone masonry bases for the buttresses remain. The buttresses were connected to the lateral walls, as evidenced by the remains of buttress mud bricks woven

into the wall construction. The instability of the stone and mud mortar base may have led to the collapse of the buttresses (Fig. 5.36).

- At the east lateral wall, one earthen buttresses immediately adjacent to the north buttress has collapsed or been dismantled. This buttress is thought to have been a later addition, as it is not structurally connected to the lateral wall of the nave.

FIGURE 5.33 (LEFT)

Deterioration of base course at east lateral wall and buttresses. Also note the modifications and shoring at the former arched opening between the buttresses.

Image: Mirna Soto, for GCI.



FIGURE 5.34 (RIGHT)

Detail view of deteriorated base course at north buttress, east lateral wall.

Image: Mirna Soto, for GCI.



FIGURE 5.35

Infill construction at former arched opening in west lateral wall. Note that infill is not connected to adjacent wall construction.
Image: Amila Ferron.



FIGURE 5.36

View of collapsed or dismantled buttresses at west lateral wall.
Image: Wilfredo Carazas, for the GCI.

It is assumed that the church originally had a quincha arch separating the nave from the presbytery, based upon the extant damage at the top of the remaining earthen piers and the existence of an arch in the nearby Church of Rondocán, which is of a similar overall design to the church of Kuño Tambo (Figs. 5.37, 5.38). The arch has since collapsed or been dismantled, and the remaining west pier exhibits cracking (Figs. 5.39, 5.40).

The adobe walls are in fair to good condition overall; however, the following damages and decay were observed:

- The west lateral wall exhibits outward displacement. The loss of the western exterior buttresses may be a cause or result of this displacement. This



FIGURE 5.37

View of intact quincha arch over mud brick piers, separating the nave from the presbytery at the Church of Rondocán.

Image: Claudia Cancino.



FIGURE 5.38

View of remaining mud brick piers at the Church of Kuño Tambo. It is likely that the piers originally supported an arch above.

Image: Claudia Cancino.

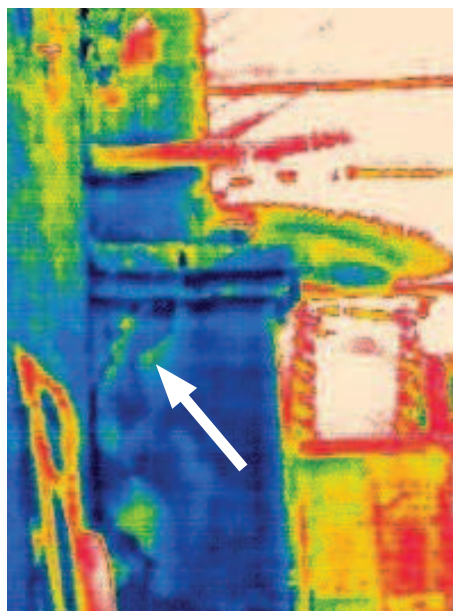

FIGURE 5.39 (LEFT)

Thermal image, showing crack in west mud brick pier of the Church of Kuño Tambo, as viewed from the nave.

Image: Amila Ferron.

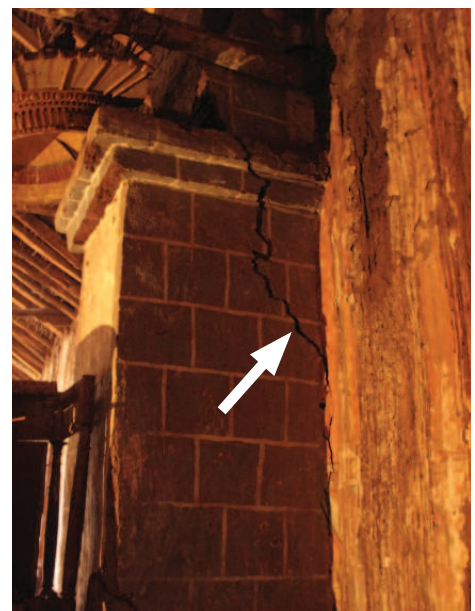

FIGURE 5.40 (RIGHT)

Crack in west mud brick pier of the Church of Kuño Tambo, as viewed from the presbytery.

Image: Claudia Cancino.

displacement appears to be related to vertical cracking in the west wall and the separation of the balcony floor framing from the west wall.

- Several other walls exhibit cracking and displacement:
 - At the baptistery wing, there are several vertical cracks, averaging 50 mm in width, in both the south and east façades, near the southeast corner. These cracks appear to be related to settlement of the base course, either due to rising damp and loss of mortar or erosion of the rock soil. These cracks may also be, in part, caused by differences in the thickness of the baptistery walls. The choir loft staircase is set into the south wall of the baptistery, reducing its thickness and causing it to behave differently during seismic events (Fig. 5.41).
 - At the south façade, vertical cracks are present at the corners where the main gable wall intersects with the buttresses and lateral walls.
 - The north gable wall is in good condition, exhibiting only minor cracking.
 - As previously mentioned, the interior piers exhibit diagonal cracking.
- At both the base and tops of the east, south, and west walls, the mud bricks are water-damaged and partially eroded, with an average depth of loss of 50 mm. A leaking roof and rising damp are the presumed sources of this damage. The walls do not appear to be unstable as a result of the water damage; however, the erosion at the top of the wall has led to failure of some roof-wall connections. This water infiltration has also led to biological growth in the tops of the mud brick walls, as well as detachment and loss of interior plaster at the base and top of walls (Fig. 5.42).



FIGURE 5.41

Crack in the south façade of the baptistery wing.
Image: Wilfredo Carazas, for the GCI.



FIGURE 5.42

Erosion at the top of the mud brick wall in the northeast corner of the altar has led to failure of the roof rafter. A wood post has been installed to temporarily support the rafter end.
Image: Sara Lardinois.

5.6.3 Floors

The choir loft floor has been altered by an extension at the northwest corner. The beam and column supporting this extension are made from unsawn tree trunks, which are different from the sawn beams and columns supporting the original choir loft floor.

The choir loft floor framing is in fair to good condition; but, it is separating from the adjacent west lateral wall of the church. The area of separation corresponds to the location where wood keys have been installed to prevent outward displacement of the wall (see section 5.6.4 below for additional discussion).

5.6.4 Roof

The entire roof covering system and most of the original wood framing members have been replaced at least one time in the building's history. When the roof was rebuilt, it appears that its form was altered. Originally, the roof, or a portion of the roof, should have been taller to accommodate the now-collapsed arch between the presbytery and nave. Where wood framing members have been replaced, vegetal ropes have been used to connect the rafters to one another and iron nails have been used to connect the rafters to the collar ties. Leather straps were originally used to connect the different framing elements.

Three wood keys, connecting the roof framing with the mud brick walls, have been installed at the far south ends of the east and west lateral walls, in order to prevent outward displacement of the walls (Fig. 5.43). This alteration suggests that there originally may have been an additional (seventh) tie beam at the south end of the main church; and that it collapsed or was removed, necessitating other reinforcing such as the keys. One wood key has been installed at the north façade of the baptistery wing.

The roof covering is in poor condition with several large areas of missing roof tiles, which have been patched with overlapping metal sheets. The roof framing itself is in fair condition. Some of the pares y nudillos trusses are deformed, giving the roof an irregular profile; and, some of the connections between different roof framing elements and the walls supporting them are broken or nonexistent. At several pares y nudillos trusses, the connection between the collar ties and rafters has failed, and the collar tie is hanging from one of the rafters or is missing. The roof framing is not anchored to the gable-end walls, and the connection between the



FIGURE 5.43
Wood key at south end of
west lateral wall.
Image: Claudia Cancino.

baptistery roof framing and east lateral wall of the main church is compromised or nonexistent.²⁸ As previously noted, water infiltration through the roof has led to detachment and loss of interior wall plasters, as well as erosion at the tops of the lateral mud brick walls. In some cases, the depth of erosion at the mud bricks is so great that the ends of the roof rafters are no longer supported by the walls. Wood rot was observed at some of the wall plates and tie beams ends.

5.7 Preliminary Findings

The following preliminary findings on the structural behavior of the church are based upon qualitative methods, including historical research and direct observations made by the investigative team during surveys carried out in 2010. The investigative team utilized their past experience with historic earthen construction to interpret that data collected through research and observation and develop preliminary ideas on the possible structural behavior of the church. These preliminary findings will be explored further in the next phases of the project through quantitative methods, including static and dynamic testing and numerical modeling analyses. Following the quantitative testing and analyses, the preliminary findings will be revised as necessary and expanded upon to provide a complete diagnosis and safety evaluation.

The preliminary findings are:

- The pares y nudillos roof trusses do not work, due to the failure or lack of connections between the rafters and collar ties. Furthermore, the connection between the rafters and the mud brick wall has failed in some locations, due to erosion of the wall and lack of continuity in the wall plate.
- Roof leaks have eroded the tops of the lateral mud brick walls, reducing the embedment and effectiveness of the tie beams.
- The thick mud brick walls are considered stable, according to the GSAP slenderness ratio criteria; however, several large openings (presently altered or infilled) in the lateral walls of the main church weaken those walls. The loss of some of the mud brick buttresses at the exterior face of those lateral walls further weakens them.
- The cause of cracking in the mud brick walls varies by location:
 - The cracks in mud brick walls at the east side of the building are caused by settlement of the foundation and base course, resulting from the weak connections between the main church and baptistery and humidity and erosion of the ground surrounding the church.
 - The cracks in the south gable-end wall are related to the thrust action of the roof framing on the lateral walls and the lack of connections between the roof framing. The lack of a tie beam in this area may also be contributing to displacement of the lateral walls and associated cracking in the south gable-end wall.

Notes

- 1 Viceroy Francisco de Toledo is considered the organizer of the Viceroyalty of Peru. During his governance, more than 1,000 Indian villages called *reducciones* were created. In Alejandro Málaga Medina's *Pueblos de indios, Otros urbanismo en la región andina*, he notes that: "Con el impulso toledano, el reordenamiento administrativo y espacial del Virreinato fue generalizado. La Visita dio como resultado un total de 614 repartimientos, 712 doctrinas y más de 1,000 reducciones o pueblos de indios." Málaga Medina's work is quoted in Jurado 2004, 127.
- 2 Zuidema and Poole 1982, 86. This 1577 document on the four regions of Cusco was based in the information provided by *curacas* (Indian authorities) from the *reducciones* (villages) created under the governance of Viceroy Francisco Toledo.
- 3 Regarding the creation of Indian villages in 1567 Juan de Matienzo wrote: "Una plaza de forma cuadrangular en el centro y luego manzanas cuadradas que se dividirían en cuatro solares por lado y sus calles anchas. La iglesia se fabricaría en una de las cuadras o manzanas de la Plaza; a su frente mesón para los españoles que estuviesen de paso en dicho pueblo, y que comprendería cuatro cuartos con techos de tejas y con caballerizas; en uno de los solares de la otra cuadra se levantarán la casa del cabildo; en el otro la huerta y servicio del hospital; finalmente en el último solar, corral del cabildo. En uno de los solares, de las cuatro manzanas que rodean la plaza, se construirá la casa del corregidor; detrás de ésta casa para el Tucuy Ricuy y cárcel, en la que habría dos cepos y cuatro pares de grillos y de cadenas. Los demás solares de la plaza serán para casa de españoles, casados que desearan vivir entre los indios. A cada cacique se le dará una cuadra o dos solares, conforme a la gente que tuviere. Así constituido cada pueblo se procedería a fijar las tasas." De Matienzo writings are quoted in Málaga Medina 1974, 153.
- 4 In the *Real Cédula* (Royal Proclamation) of 1538 given in Valladolid, Spain, Don Antonio de Mendoza committed to create villages for Indians in all the Nueva España (Mexico), with well-planned streets and squares, a church, a jail, and houses for the local authorities, Indian authorities, and mayors. Several instructions were given on how to create these villages (Villacorta Santamato 2005).
- 5 The instructions given by the *Real Audiencia* (Royal Court) of Lima to the visitors on November 15, 1561 reads: "Les dareys a entender que los queremos reducir a pueblos porque tengan mejor gobernación entre sí, y así mesmo dareys jurisdicción para que ellos tengan entre sí su república fundada y se gobiernen de los que entre ellos pasare y tratare y para que se les pueda enseñar la doctrina cristiana y para esto conviene que se reduzgan a pueblos." The text of these instructions are quoted in Villacorta Santamato 2005.

- 6 Constitución 2 of the *Primer Concilio Provincial Limense* states: "Que se hagan iglesias en los pueblos de indios, y en el modo que se han de tener de hacer. – Ítem por cuanto, por la bondad y misericordia de Dios nuestro señor, en los más pueblos y provincias de indios hay ya muchos de los cristianos, y cada día serán más; y es razón que haya templos e iglesias donde Dios nuestro Señor sea honrado y se celebren los oficios divinos e administren los sacramentos, e los indios concurran a oír la predicación y doctrina: ss. ap. Mandamos que los sacerdotes que estuviesen en la doctrina de los naturales en los pueblos de indios den orden y procuren con diligencia como en cada repartimiento, en el pueblo principal donde esté el principal cacique, se haga una iglesia conforme a la cantidad de la gente en la cual se administren todos los sacramentos si no fuera en caso de necesidad. Y procurará el tal sacerdote de adornarla de arte que entiendan la dignidad del lugar y para lo que se hace, dándoles a entender que es aquel lugar dedicado para Dios y para el culto y oficio divinos, y para que concurramos a pedir perdón a Dios de nuestros pecados, y que en él no se han de hacer cosas ilícitas ni den lugar a ellos. Y en los demás pueblos pequeños donde que no hubiese posibilidad para hacer iglesia, hagan una casa pequeña, a manera de ermita para este efecto, donde pongan un altar adornado con una imagen o imágenes, en la mejor manera que pudieren, y donde fuera tan pequeño que para esto no haya posibilidad, al menos señalen un lugar decente con una cruz, donde se les diga la doctrina y platique las cosas de la fée." Quoted in Vargas Ugarte 1951, 8.
- 7 Constitución 77 of the *Segundo Concilio Provincial Limense* states: "Que a cada parroquia no se le den ni señalen más de cuatrocientos indios casados, con los cuales entran los demás que les pertenecen como muchachos, viejos, huérfanos y forasteros." Quoted in Catholic Church, Province of Peru, Concilio Provincial (3rd: 1582-1583) 1982, 169.
- 8 Villacorta Santamato 1987, 116.
- 9 The Third Constitution indicated that old temples should be destroyed; and, if the location was appropriate, a new church should be built in its place.
- 10 The Spanish translation of Plaza de Armas is "weaponry square." This is a typical name for main plazas in many towns in Peru and is derived from the plazas' use for armaments storage during the Spanish Viceroyalty period.
- 11 Villacorta Santamato 1987, 118–135.
- 12 According to documents located in the Acomayo Parish archive, "el Templo Santiago Apóstol de Cunutambo data del año 1681" (Archivo Parroquial de Acomayo. Sección Colonia. Libro de Fábrica de la Viceparroquia de Cunutambo. Leg. IX 1, 1,7 1681).
- 13 According to a 1689 document, San Juan de Quihuares was the parish which included the villages of Pumaquehuar and Cunutambo. Cited in Villanueva Urteaga 1982.
- 14 According to documents located in the Acomayo Parish archive: "La Iglesia Santiago Apóstol poseía terrenos y propiedades en los sectores del Hanansaya y Urinsaya de Cuñutambo, abarcando 3 topos de cultivos de maíz y 1/2 topo de tierras de cultivos de granos (trigo y cebada)" (Archivo Parroquial de Acomayo. Sección Colonia. Libro de Fábrica de la Viceparroquia de Cunutambo. Leg. IX 1, 1,7 1681.)
- 15 Archivo Arzobispal del Cusco. Libro de Fábrica e Inventario de Bienes y Alhajas perteneciente al Repartimiento de Quispicanchi. Año 1689.
- 16 Villanueva Urteaga 1982, 128.

- 17 The 1767 inventory reported: "dos cálices con sus respectivas patenas, tres cruces de guión, un incensario, un hostiario, un viril para el sacramento, dos copones de plata grande y chico con tapa dorada, crucecita de plata, una corona de plata de la Virgen Rosario y entre sus ornamentos cinco casullas con sus manípulos y estolas de diferentes colores, dos capas de San Cristóbal y Patrón Santiago, dos mangas de cruz, tres frontales de lienzos y dos almaizales" (Archivo Arzobispal de Cusco. Libro de Fábrica y Cofradía. Rondocan. Año 1767–1783: Registro realizado en el periodo del cura Manuel de la Sota).
- 18 The nineteenth century inventories are located in multiple locations, including:
 - Archivo Arzobispal de Cusco. Libro de Fábrica y Cofradía. Rondocan 1830–1832.
 - Archivo Regional de Cusco. Grupo Documentario Cabildos de Cusco. Leg^o 83. C 16 Año 1816–1817.
 - Archivo Regional de Cusco Grupo Documentario Tesorería Fiscal. Libro de Matriculas de la Provincia de Quispicanchi. Año 1830–1838. Libro 01.
- 19 Seismic zones are defined in Capítulo II, Parámetros de Sitio of the *Norma Técnica de Edificación E.030: Diseño Sismorresistente*, which is available online at http://www.igp.gob.pe/web_page/images/documents/ltorres/norma_tecnica_edificaciones.pdf.
- 20 Information on earthquake dates, epicenter locations, and moment magnitudes (M_w) is summarized from United States Geological Survey (USGS), Historic World Earthquakes, Peru, http://earthquake.usgs.gov/earthquakes/world/historical_country.php#peru. Estimates of moment magnitudes for the 1943 Yanaoca, 1913 Abancay, and 1746 Lima earthquakes are not available in the summary.
- 21 According to the local community, the church was affected by an earthquake around 1939. This may be a reference to the 1943 Yanaoca earthquake.
- 22 The term *English bond* is a common English-language architectural word used to describe a type of masonry bond pattern.
- 23 Criteria for determining slenderness ratios are based upon those provided in Tolles, Kimbro, Webster, and Ginell 2000.
- 24 While the baptistery and sacristy wings are beneficial in that they provide additional bracing for the east lateral wall, their added weight also introduces irregularities into the overall structural performance of the church.
- 25 *Kur Kur* is a type of highland bamboo that is commonly used for roof coverings in the Cusco region. The canes are thin and without voids in the center.
- 26 The term *Spanish style* is used to describe roof tiles having a semi-cylindrical shape and laid in alternating courses so that a tile with its convex side up is adjacent to and interlocking with a tile having its convex side down.
- 27 According to Juan Julio García, former director of the Cusco regional office of the Ministerio de Cultura del Perú, this technique is derived from the Incas, who used it to tie roofs to stone gable walls.
- 28 The ridge of the sacristy roof is higher than that of the baptistery roof, and thus intersects with the roof, not the east lateral wall, of the main church.

Casa Arones

6.1 Summary

Located in the historic center of Cusco (Fig. 6.1), Casa Arones is a typical residential structure dating to the seventeenth century. Originally constructed as a single-family dwelling with ground floor commercial spaces, the building was later divided into multiple residential units. The structure is currently largely unoccupied; however, the owners, a non-governmental organization, plan to rehabilitate the house. The two-story 1100 m² building exhibits many of the design features and materials typical of residences from the Spanish Viceroyalty period, including moderately thick mud brick walls over a rubble stone masonry foundation, wood-framed gable roofs, and galleries with fired brick and stone masonry arcades surrounding a central patio (Fig. 6.2). The building has been enlarged and altered over the course of its history; however, many of these alterations date to the eighteenth and nineteenth centuries and may be considered historically significant in their own right. Casa Arones is in fair to poor condition overall. The preliminary findings indicate that most observed damages are the result of lack of maintenance. Although the building's structural systems are intact, many elements are unstable, particularly the masonry arcades. Casa Arones is vulnerable to future seismic events due to its unstable structural elements, the lack of transverse walls at the second floor, and the poor condition of the roof which has damaged the walls and thus the roof-wall connections. An emergency shoring system was recently installed to better protect the structure until a full conservation or rehabilitation project is undertaken.

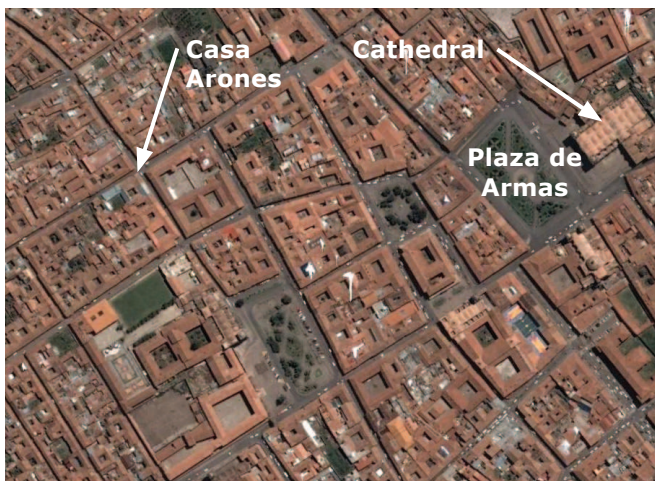

FIGURE 6.1
Satellite image showing the location of Casa Arones in relationship to Cusco's main square and cathedral.
Image: © 2012 DigitalGlobe, © 2012 Google.



FIGURE 6.2
View of Casa Arones, from the northeast.
Image: Sara Lardinois.

6.2 Historical Background, Context, and Significance

6.2.1 Historical background and context

The city of Cusco is located at 3,400 m above the sea level in the Peruvian Andes, near the Urubamba Valley. The city is the political capital of both the Cusco region and province. Cusco was also the capital of the Inca Empire and is today known as the Historic Capital of Peru.¹ As of 2007, the city had a population of 358,935; but, as a major tourist destination, it receives nearly 1.5 million visitors per year. Casa Arones is located in the historic center of Cusco in the Barrio de Nueva Alta, within the parish of San Pedro. During the Spanish colonial period, this place was known as *La Parroquia de Hospital de los Naturales* (Parish of the Hospital of the Indians), as it was home to the San Pedro Hospital. Prior to that it was known as *Chaguaytapra*.

The earliest known occupation of this area dates back more than 2,000 years. In 1941 the American archaeologist John Rowe found, in the adjacent neighborhood of Santa Ana, fifth to second century BCE pottery made by the Chanapata culture who had been living in the area since the eighth century BCE.

During the period of the Inca Empire, called Tahuantinsuyo by the Incans, Cusco was a complex urban center with distinct religious and administrative functions that were surrounded by clearly delineated areas for agricultural, artisanal and industrial production. The area where Casa Arones is located was used for agricultural purposes.² *Andenes* (agricultural terraces constructed with stone masonry walls), located on the Carmenca hill to the northwest, descended into the area where Casa Arones is currently located.³ During the sixteenth century, this sector of Cusco was urbanized and the existing configuration of the *andenes* influenced the pattern of urban development.⁴ At the time, this sector was called Picchu; and, it extended as far as the trail to Contisuyo, one of the four *suyos* or regions of the Inca Empire, located southwest of Cusco.⁵ This trail later took the name of Calle Hospital. As the *andenes* became obsolete in this area, portions of the terrace walls were dismantled as needed and the stones were reused in the construction of new buildings. Other portions of these terrace walls still remain, and many of the houses that are built over the former terraces incorporate the stone walls into their foundations. In the case of Casa Arones, reused Inca stones are found in some areas of the foundation. In the sixteenth century, the area was considered a *huaca*, or sacred place, by the indigenous people;⁶ and the *ayllus* living in the area called it Chacuaytapara.^{7, 8}

In 1569 Don Francisco de Toledo arrived in Peru to organize the Viceroyalty. He traveled to Cusco, where he lived for two years (1570–1572), and began to organize the city, creating parishes and indigenous *reducciones* (villages). During that time, the city grew along the trail to the Contisuyo and thus extended its boundaries southwest;⁹ however, the area of Picchu was not yet occupied by the Spaniards.

During the seventeenth century, the neighborhood where Casa Arones is located took the name of Barrio de la Calle Chawaytapra; and, it later took the name of Calle Nueva Alta, which is a name still used in reference to the street at the east side of Casa Arones today. During the first part of the seventeenth century, merchants and *criollos* (persons of pure Spanish descent born in the Viceroyalty) occupied Piccho (Picchu) and Chaguaytapra (Nueva Alta), as well as the neighborhoods of Matara, Pumancsaca (Umachata), and Quechua;¹⁰ and they continued to do so until 1650 when a large earthquake destroyed many parts of the city.¹¹ After that time, Spaniards and mestizos lived in areas of Picchu, Chaguaytapra (Nueva Alta),

Ayhuayco, Calle Hospital, and Calles Matara. During the eighteenth century, this sector was primarily residential in nature.

In 1840, following Peruvian independence, the definitive separation of the former territory of Alto Peru, or Bolivia, from Peru triggered a crisis in Cusco. The city lost a large part of its population and fell into a decline that continued until the first half of the twentieth century. During this period, houses were not well-maintained. Many houses were rented out or sold; and some of them, including Casa Arones, were subdivided and occupied by several families. According to an 1862 census, an average of four families, each with eight members, lived in each house in the Nueva Alta neighborhood.

The construction of Casa Arones is thought to date to the end of the sixteenth century or beginning of the seventeenth century, prior to the great earthquake of 1650. The earliest reference to the structure is in 1643, where it appears in *El Plano Más Antiguo Del Cusco*.¹² In 1651, one year after the earthquake, the earliest known deed record shows that the house was sold to Pedro Carrasco, beginning a long chain of ownership for the house.¹³ Sometime between 1672 and 1773 the house was sold to Don Cipriano Oblitas; and for this reason Casa Arones is sometimes referred to as Casa Oblitas in historic and current documents. The structure is currently unoccupied; however, a caretaker is on site several days a week to look after the building. The house is currently owned by a non-governmental organization, Guamán Poma de Ayala, which is planning to rehabilitate the house.

Casa Arones exemplifies many of the characteristics of a typical Cusco house, with two patios, a *zaguán* (entrance hall) providing access from the street to the main patio, and arcaded galleries surrounding the main patio which allowed for circulation between rooms and exterior spaces. This configuration is thought to be based upon the traditional residential architecture of the Mediterranean region; however, in Cusco, the Spaniards adapted the Mediterranean tradition to the existing Incan building typology—the *kancha*, which was a rectangular enclosure with three or more rectangular buildings placed symmetrically around a central open space.¹⁴ Both the patio and *kancha* were similar in function; however, due to the symmetrical placement of buildings around the central space, the *zaguán* was not located in the center of the patio but rather at the side of it. This placement of the *zaguán*, while typical of Spanish structures in Cusco, is quite different from the prevailing patterns in Lima. In the case of Casa Arones, the house was not actually constructed over an earlier *kancha*, but rather earlier Incan *andenes*.

The house was originally constructed as a single family dwelling, with commercial spaces on the ground floor along Calle Arones to the East; and it was later converted to multiple residential units. The building has been enlarged and altered multiple times since its original construction. As a result, it incorporates a number of different architectural styles from different periods. The stone arcade at the gallery at the north side of the main patio is typical of late sixteenth and early seventeenth century constructions and is thought to be one of the oldest remaining parts of the house. The pavement in the main patio is also typical of sixteenth and seventeenth century building traditions. Remains of mural paintings, likely dating to the eighteenth century, have been found in the upper floor of the house. The main rooms in the house are covered with late nineteenth to early twentieth century wallpaper. At the exterior, the stone entrance portal reflects both Renaissance and Mannerist influences, while the wood door itself follows the Mudejar style. The second floor balconies likely date to a later period. Historic drawings indicate that the pattern of openings along the street façades has changed over time—a drawing

prepared in 1776 shows a single door, corresponding the location of the current entrance portal, along Calle Arones. Two door openings are shown along Calle Nueva Alta; however, there are currently only windows at that façade.¹⁵ The house has suffered from earthquake-related damages. In 1986, the staircase and second patio collapsed as a result of an earthquake.

6.2.2 Significance

Casa Arones is located within the boundaries of the City of Cuzco, which was inscribed on the UNESCO World Heritage list in 1983 (Fig. 6.3).¹⁶ Casa Arones was registered as national monument on December 28, 1972, under Resolución Suprema R.S. No. 2900, which was published on January 23, 1973. It is important to note that in many records, including those of the former Instituto Nacional de Cultura, Casa Arones is listed under its alternative name of Casa Oblitas. The building is significant as a contributor to the historic urban landscape, located in a neighborhood comprised of earthen buildings of a similar age, size, design, and construction techniques, which was formerly an Incan agricultural sector. Casa Arones is also architecturally significant as a representative example of a typical seventeenth century residence in Cusco.

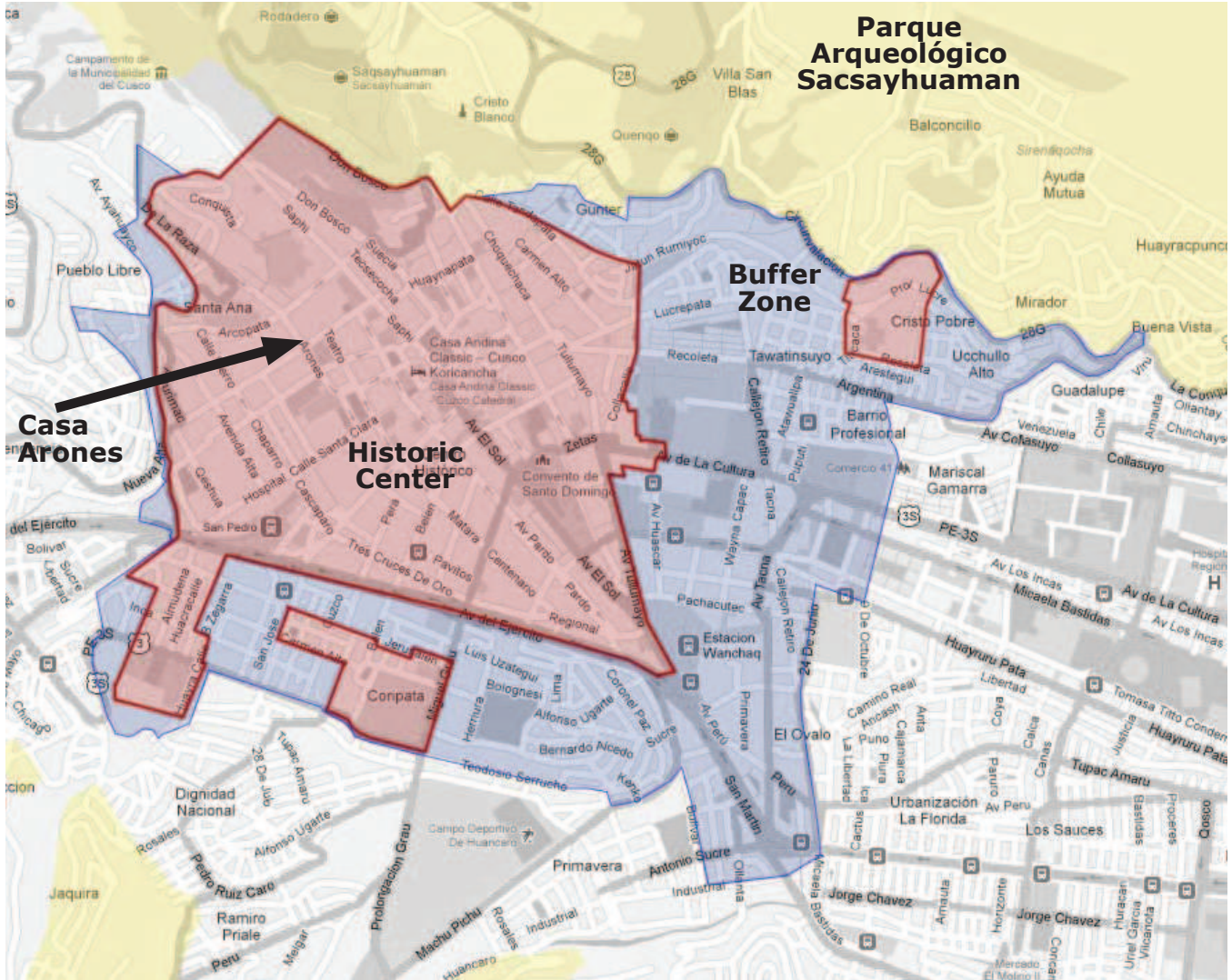

FIGURE 6.3
Plan showing the boundaries of the historic center of Cusco (red), buffer zone (blue), and archaeological zone (yellow).
Image: © 2013 Google, with additional annotations by GCI.

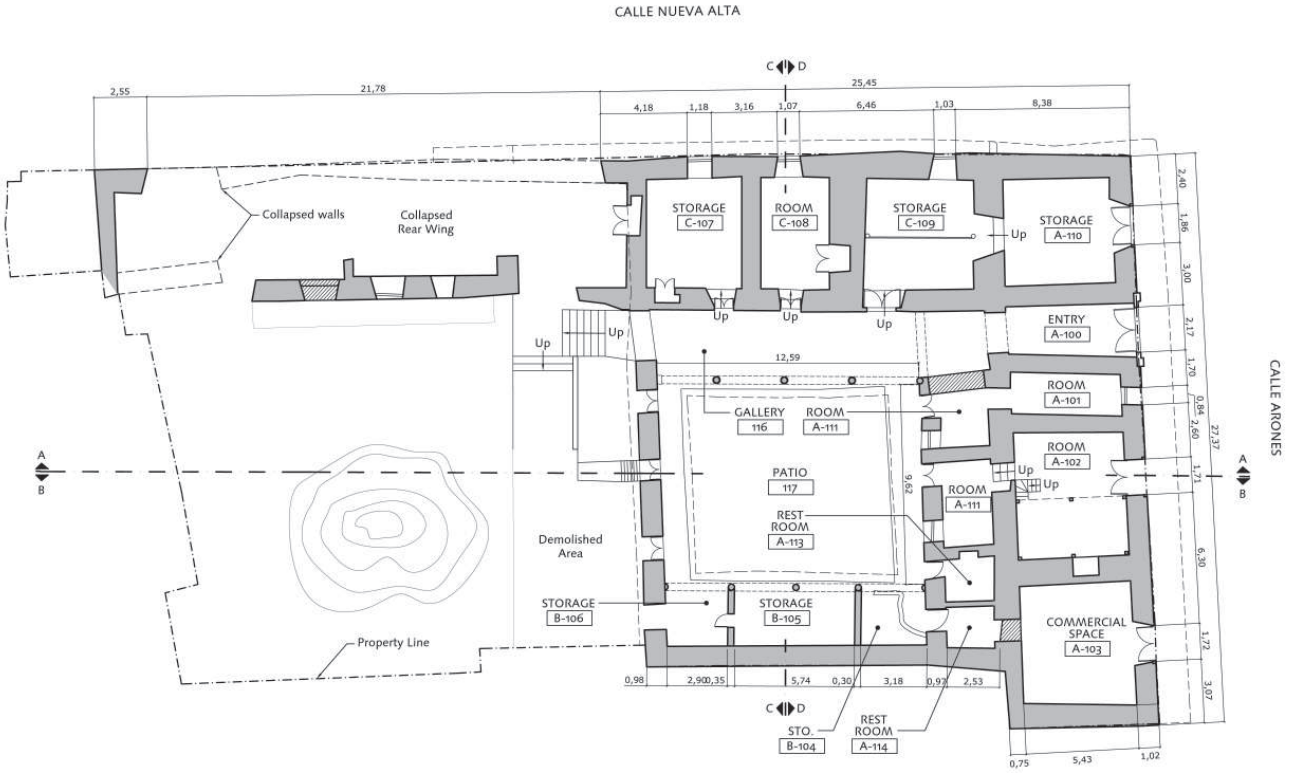

FIGURE 6.4
First floor plan, Casa Arones.
Drawing: Base drawing prepared by Enrique Estrada and edited by the GCI.

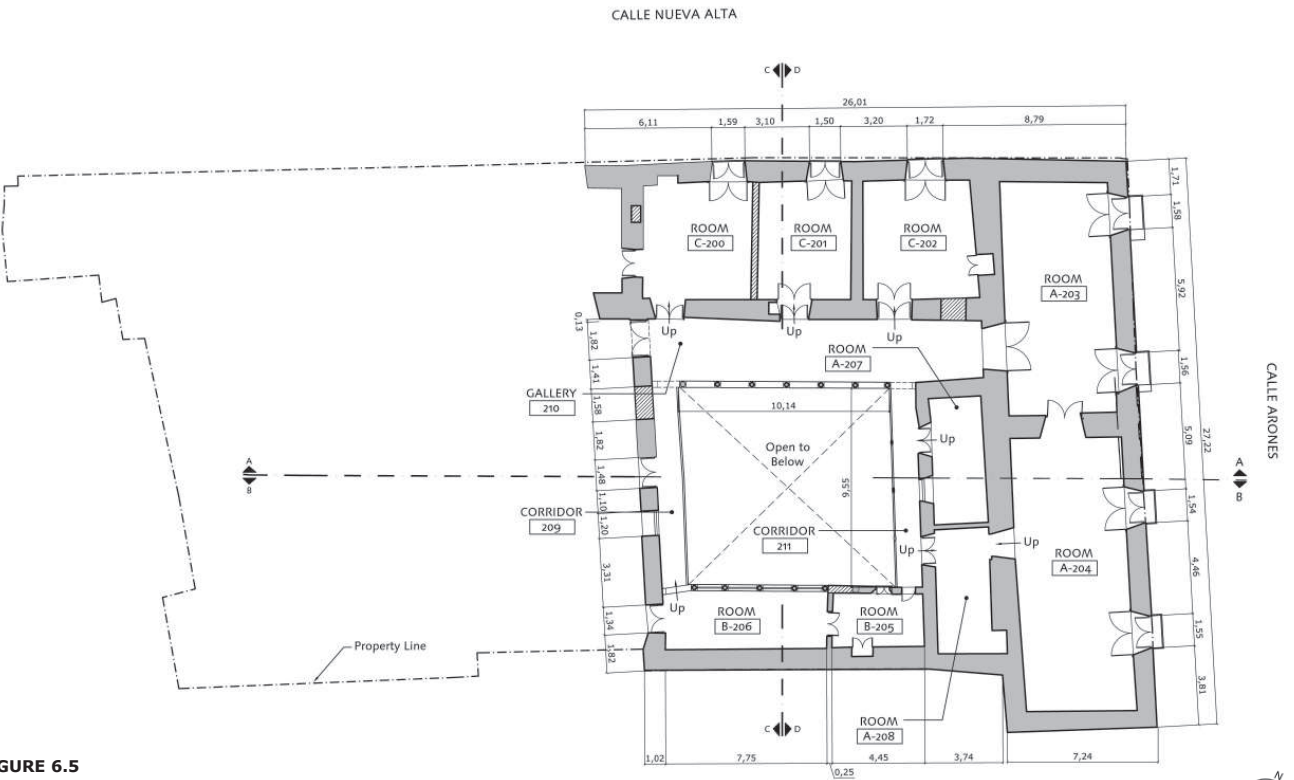

FIGURE 6.5
Second floor plan, Casa Arones.
Drawing: Base drawing prepared by Enrique Estrada and edited by the GCI.

6.3 Architectural Description

Located on an urban city block at the southwest corner of the intersection of Calle Arones and Calle Nueva Alta, the south and west exterior walls of Casa Arones immediately abut the historic two-story earthen structures on the adjacent properties. A narrow, stone paved sidewalk runs along the north and east facades of Casa Arones. The site gently slopes downward from the northwest to southeast, with an approximate change in grade of 1.90 m from west to east and also from north to south.

The two-story house consists of multiple narrow wings arranged around a central open-air patio (Figs. 6.4, 6.5), with a second patio and garden to the West which is not part of this construction assessment (Fig. 6.6).¹⁷ The 1100 m² building is nearly square in plan, measuring approximately 25 m in the East–West direction (along Calle Nueva Alta) and 27 m in the North–South direction (along Calle Arones).¹⁸ The main mass of the building is located in an L-shaped wing bordering the streets to the North and East. A smaller wing is situated to the south of the patio, and a mud brick wall separates the west side of the patio from the collapsing and demolished rear wing of the house to the west. Each wing is constructed of mud brick walls over stone masonry foundations and quincha is used for some of the interior partitions. The north and south sides of the patio are bordered by galleries with fired brick and stone masonry arcades. Each leg of the L-shaped wing is covered with a wood-framed gable roof, set perpendicular to the other, while the southern wing has a shed roof.

The exterior appearance of the house is largely defined by its planar wall surfaces, irregularly-spaced and shallowly-recessed window and door openings, and tiled gable roofs. The east façade is the primary façade and, thus, is more highly articulated than the north façade (Fig. 6.7). The main entrance portal consists of a monumental pair of Mudejar style wood doors framed by a stone entablature and rusticated Doric pilasters (Fig. 6.8).¹⁹ This portal is not centered on the façade, rather it is located near the north end of the façade, so that it axially aligns with the interior gallery at the north side of the patio. A small window with decorative iron security bars is located at the left side of the entry portal. Three pairs of large doors provide separate access to each of the ground floor commercial spaces. At the second floor, there are four pairs of glazed doors with wood shutters, each providing access to small wood-framed balconies with decorative iron railings and wood skirting. Based upon the remnant sawn-off beam ends embedded in the wall, it appears that at one time there was a larger balcony wrapping around the northeast corner of the building (Fig. 6.9). At the north façade, the intersection of the two main gable roofs is visible, with the gable wall under the north–south ridge to the east and the eaves of the east–west ridge to the west. There are four small windows with iron security bars at the ground floor. At the second floor there are three pairs of glazed doors with wood shutters and decorative iron balconettes, with a smaller window at the far west end (Figs. 6.10, 6.11). At the north and east façades, the second floor openings do not align with the ground floor openings. Both of the gable roofs have deep overhangs, with exposed wood framing at the open eaves. Exterior materials include exposed rubble and cut stone at the base course, plastered mud brick walls, and terra cotta roof tiles

At the interior of the building, each wing is typically one-room wide; and interior circulation occurs via the central patio and surrounding galleries and corridors (Figs. 6.12–6.14). Originally, there may have been a staircase in the north or east

FIGURE 6.6
Collapsing rear wing of house
along Calle Nueva Alta (not part
of construction assessment), with
shoring and temporary roof in
place.
Image: Amila Ferron.



FIGURE 6.7
East façade, along Calle Arones.
Drawing: Base drawing prepared
by Enrique Estrada and edited by
the GCI.

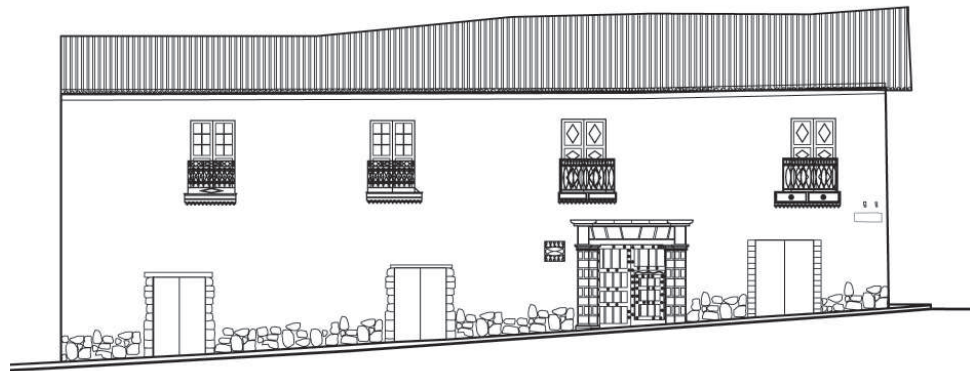

FIGURE 6.8
Detail view of entrance portal at east façade.
Image: Sara Lardinois.



FIGURE 6.9
An example of an extant balcony at a nearby building on Calle Arones. The sawn-off beam ends at the northeast corner of Casa Arones suggest that it once had a similar balcony.
Image: Sara Lardinois.



FIGURE 6.10
North façade, along Calle Nueva Alta. The far right end of the façade corresponds to the location of the collapsing rear wing.
Drawing: Base drawing prepared by Enrique Estrada and edited by the GCI.



FIGURE 6.11
Partial view of north façade, to the west of the gable wall.
Image: Sara Lardinois.



FIGURE 6.12
View of central patio, looking northwest.
Image: Claudia Cancino.



FIGURE 6.13
View of gallery arcade at north side of the patio.
Image: Amila Ferron.



FIGURE 6.14
View of cantilevered wood balcony at east side of patio.
Image: Sara Lardinois.



FIGURE 6.15
View of typical square-shaped room, C-201.
Image: Sara Lardinois.



FIGURE 6.16
View of room A-204—a long rectangular second-floor room along
Calle Arones—looking south.
Image: Claudia Cancino.

wing; however, the most recent staircase appears to have been located in the now demolished rear wing. This staircase collapsed during an earthquake within the last 25 years, along with the rear west wing; and at the present time there is no means of vertical circulation between the two floor levels, other than a temporary wood ramp. The gallery arcades at the north and south sides of the square-shaped patio consist of stone columns supporting stone masonry arches at both the first and second floors. The second floor arches and columns are half the size of the first floor arches and rest on a stone masonry parapet wall. It is possible that there was once a similar arcaded gallery at the east side of the patio; however, it appears that it was filled in at some point to create a series of narrow rooms at both the first and second floors and a cantilevered wood balcony was constructed to allow for circulation. Most of the rooms at the first and second floors are small, with square-shaped floor plans (Fig. 6.15); however, there are two large rectangular rooms at the second floor of the east wing, which open up to the exterior balconies (Fig. 6.16). Interior finishes include stone paving in the entry hall, galleries, and patio; stone pavers, brick pavers, ceramic tiles, wood planks, and exposed earth flooring at the first and second floors; plastered walls with decorative painting at the mud brick walls bordering the galleries or wallpaper in some second floor rooms; and, exposed wood framing at the first floor ceilings and a combination of flat plastered false ceilings and exposed wood framing at the second floor.

6.4 Geological and Environmental Description

6.4.1 Geological description and seismic history

As previously noted, Casa Arones (lat 13°31'0.39" S; long 71°58'58.87" W) is built over the remains of Incan agricultural terraces with stone masonry walls. Several watercourses flow through the area.

The building is located in a level 2 seismic risk zone, as classified by the Peruvian Building Code, which is the middle level on a scale of 1 to 3.²⁰ As the house was constructed in the seventeenth century, it has been subject to a number of seismic events throughout its history, including the 1986 Cusco earthquake (M_w 5.3), the 1950 Cusco earthquake (M_w 6.0); the 1943 Yanaoca earthquake; the 1913 Abancay earthquake; and the 1650 Cusco earthquake. It is possible that the building was also subject to the 1746 Lima and 1687 Lima (M_w 8.5) earthquakes.²¹

6.4.2 Regional climate

Cusco's annual average maximum temperature is 22°C and the minimum is 3° C; however, in the winter, lows may drop below 0°C. As measured since 1976, the maximum average annual rainfall is 1125 mm and the minimum is 460 mm. It rains over 100 days each year.

6.5 Structural Description

The following sections describe the different structural materials, elements, and systems making up Casa Arones (Fig. 6.17). Their current condition and any irregularities, alterations, damages, and decay observed during the construction assessment survey are described in greater detail in section 6.6 that follows the structural description.

6.5.1 Survey sectors

For the purpose of conducting the construction assessment survey, the building was divided into four sectors, each encompassing two stories of the building (Fig. 6.18). The sectors were selected based upon differences in structural configuration, primarily related to the direction of the floor joists and roof rafters. The different sectors may also reflect the development of the building over time. The sectors are as follows:

- **Sectors A1 and B1:** The original two-story mud brick portion of the house along Calle Arones, with a gable roof oriented along a North–South axis. These sectors include multiple commercial spaces at the ground floor and two large rooms at the second floor.
- **Sectors A2 and B2:** The two-story mud brick portion of the house along Calle Nueva Alta, with a gable roof oriented along an East–West axis. These sectors are either original to the house or are an early addition. They include three rooms each at the first and second floors, as well as the gallery bordering the central patio with a fired brick arcade at the first floor and a stone masonry arcade at the second floor. The walls are typically of load-bearing mud brick construction; however, some of the second floor partitions are constructed of quincha.
- **Sectors A3 and B3:** Not used.

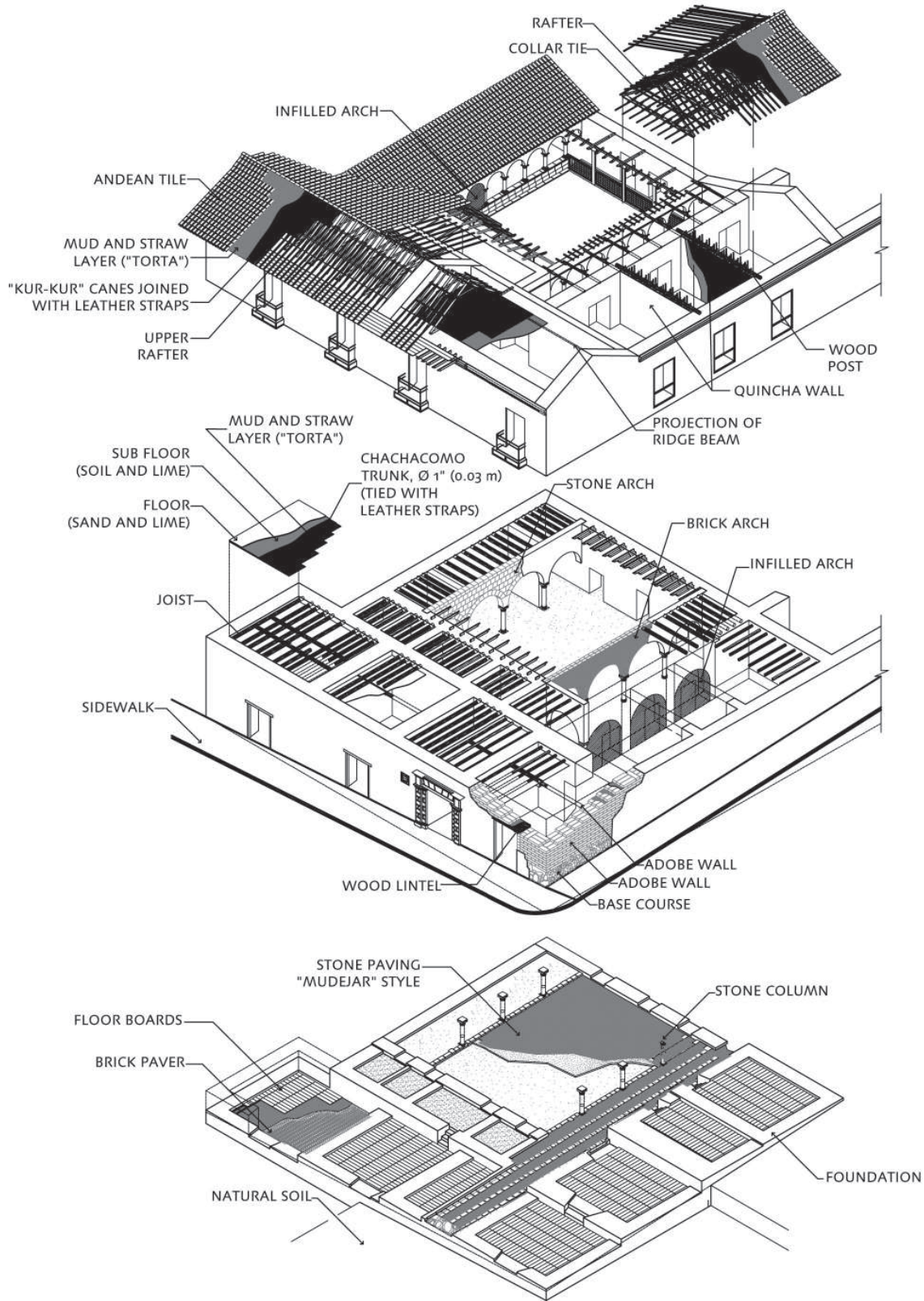

FIGURE 6.17
Overall structural scheme for Casa Arones.
Drawing: Mirna Soto, for the GCI.

- **Sectors A4 and B4:** A narrow, two-story mud brick portion of the house between Sectors A1/B1 and the patio. Originally, this area may have been a two-story gallery, similar to those at the north and south sides of the patio. Previous research has suggested that the gallery was infilled in the nineteenth century to create a series of small rooms.²² The infill walls are primarily constructed out of mud bricks; however, quincha is used for some of the interior partitions. These sectors also include the cantilevered wood-framed exterior corridor at the second floor which links the north gallery (sector B2) with the south addition (sector B5). These sectors are covered by an extension of the western slope of the north-south gable roof.
- **Sectors A5 and B5:** A narrow, two-story mud brick portion of the house bordering the south side of the patio. It appears that this space was originally an open gallery, mirroring the design of the gallery at the north side of the patio (sectors A2 and B2). The design and configuration of the arcades at either side of the patio are similar; however, in these sectors both levels of the arcade are constructed in stone masonry. The south wall, abutting the adjacent property, is constructed with mud bricks. Previous research has suggested that the gallery was infilled in the nineteenth century to create a series of small rooms.²³ Mud brick and quincha are used for the interior partitions. These sectors are covered by a shed roof sloping downwards toward the patio.

Due to the presence of stored construction materials or other items in some rooms and locked doors at other rooms, it was not possible to fully inspect every room in each of the sectors during the construction assessment survey field campaigns.

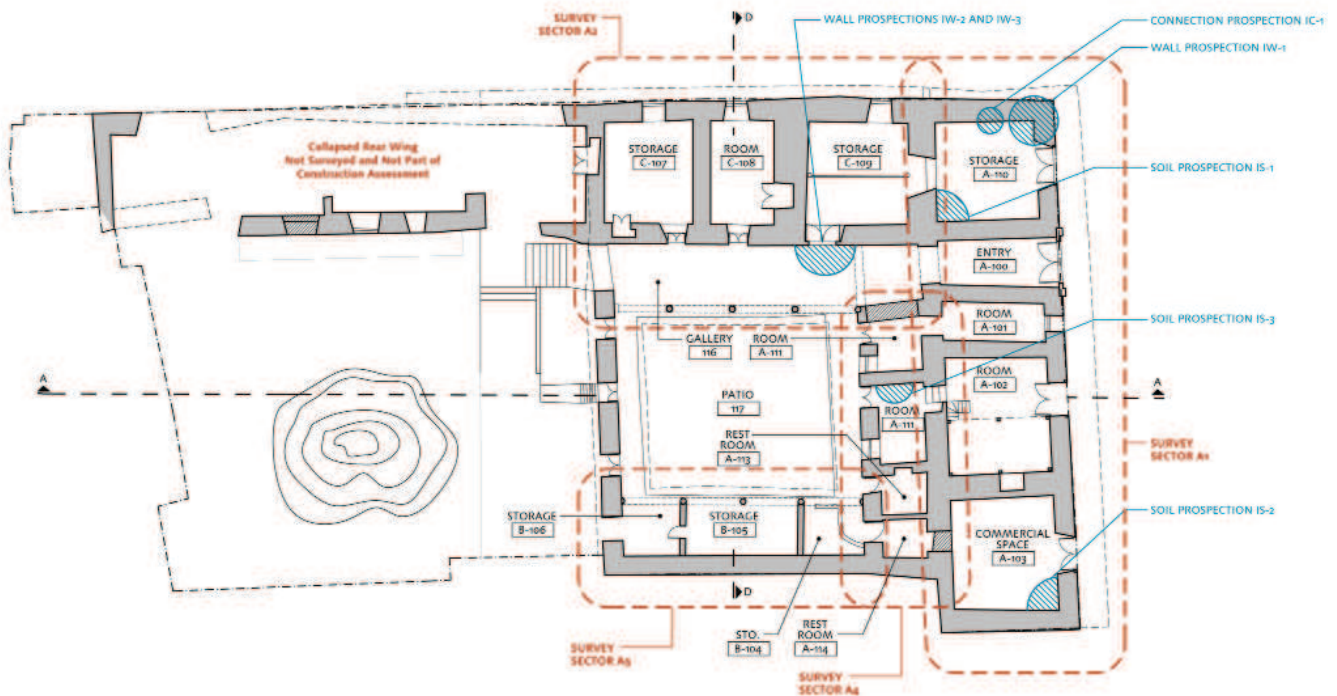

FIGURE 6.18

First floor plan, showing sector and prospection locations.

Drawing: Base drawing prepared by Enrique Estrada and edited by the GCI.



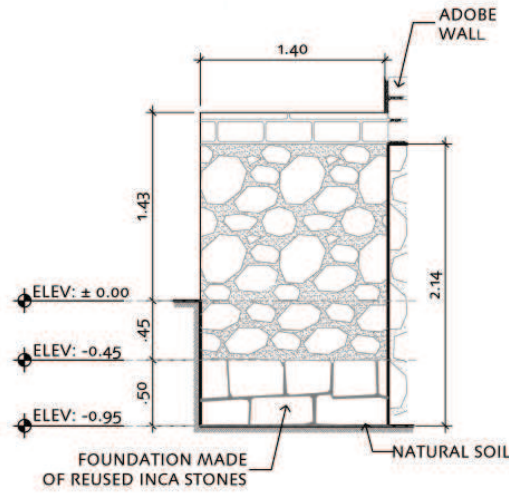

FIGURE 6.19
Prospection IS-2, illustrating the foundation configuration at the east façade wall at the southeast corner of the building, sector A1.
Drawing: Mirna Soto, for the GCI.



FIGURE 6.20
Prospection IS-2, photographic view of reused Inca stones.
Image: Mirna Soto, for the GCI.

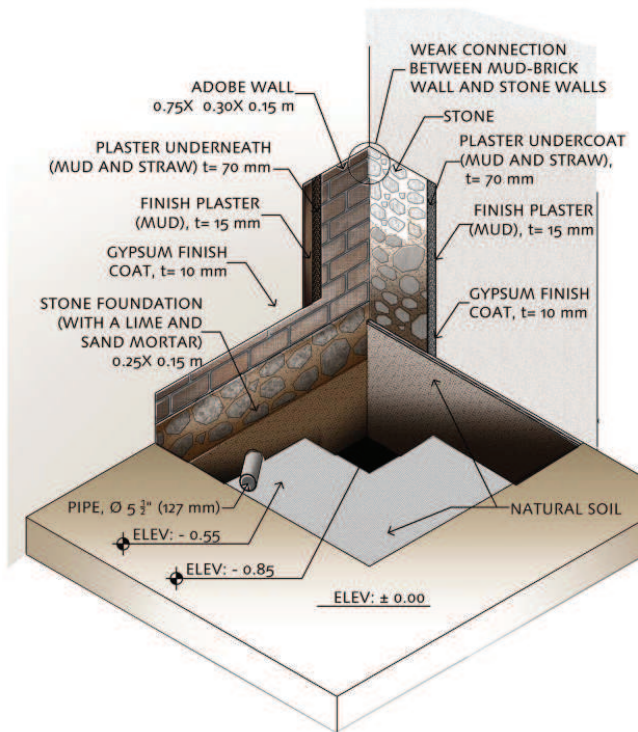

FIGURE 6.21
Prospection IS-1, showing the foundation and base course configuration at the southwest corner of room A-110, sector A1.
Rendering: Jabdiel Zapata, for the GCI.

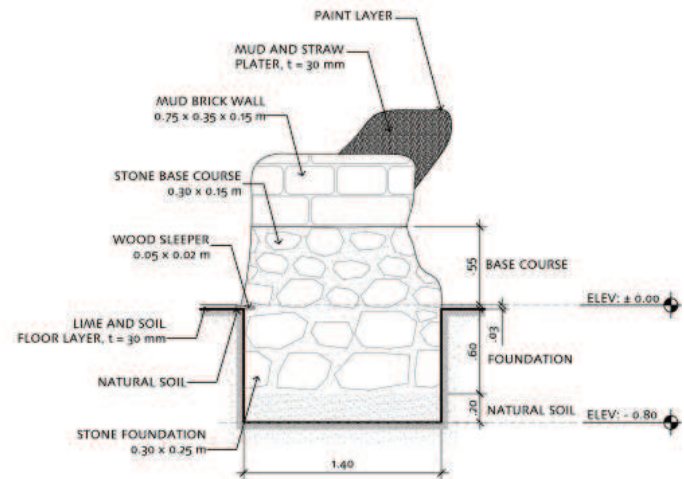

FIGURE 6.22
Prospection IS-3, illustrating foundation configuration at north wall of room A-111, sector A4.
Drawing: Mirna Soto, for the GCI.

6.5.2 Foundations and base course

The building foundation typically consists of a manmade rubble stone masonry base course and foundation bearing on the natural soil; however, the configuration varies throughout the building. Prospections carried out during the construction assessment survey field campaigns identified the following foundation configurations:

- **Sector A1:** At the southwest corner of room A-110, soil prospection IS-1 revealed two different foundation configurations. Along the south wall, there is a 0.47 m high rubble stone masonry foundation, which extends approximately 0.25 m above the floor level. The west wall marks a change in floor level between room A-110 and room C-109 to the west that is related to the natural upward slope of the site from east to west. In this location, the bottom of the rubble stone masonry foundation corresponds to the floor level in room A-110 and extends upwards to a height of at least 1.42 m; and it is possible that the stone construction extends across the whole height of the wall at the first floor. The average face size of the foundation stones is 0.25×0.15 m. A sand and lime mortar is used (Fig. 6.21).
- **Sector A1:** At the southeast corner of sector A1, in room A-103, soil prospection IS-2 revealed a 2.0 m high rubble stone masonry foundation with a mud and lime mortar, extending approximately 1.2 m above the floor level. At the base of the foundation along Calle Arones, two courses of large cut stone blocks are present, which are likely reused stones from the Inca period. This reused stonework is approximately 0.5 m high and extends approximately 0.5 m beyond the face of the rubble stone foundation above. The reused Inca stones are also set in what appears to be a mud and lime mortar (Figs. 6.19, 6.20).
- **Sector A4:** Soil prospection IS-3 revealed a 0.55 m high rubble stone masonry base course over a 0.60 m deep foundation. The typical face dimensions of the base course stones are 0.30×0.15 m, and the foundation stones typically measure 0.30×0.25 m. The stones are bonded with a lime mortar (Fig. 6.22).

As observed in several other locations in the building, the base course typically ranges in height from 0.55 to 1.50 m above the floor level. At Calle Nueva Alta, the rubble stone base course is exposed at the exterior and projects beyond the face of the wall above to form a sloped base. Although typically constructed of rubble stone masonry, the exterior face of the base course along Calle Arones is finished with cut stones having a smooth face.

6.5.3 Walls

6.5.3.1 Load-bearing mud brick masonry walls

Most walls at Casa Arones are of load-bearing mud brick construction, with the exception of the arcades surrounding the patio and several interior partitions. The mud brick walls typically have a plaster finish at both the interior and exterior faces. The walls can be classified as moderately thick in relationship to their height, with a slenderness ratio between 6 and 8.²⁴ In sectors 1, 2, and 5, the walls generally vary in thickness from 0.90 to 1.10 m; however, the primary north–south wall separating sector A1 from A2 and A4 is somewhat thicker at 1.20 m, presumably because it serves as a retaining wall against the natural slope of the site. The north

FIGURE 6.23

Prospection IW-1, isometric view showing mud brick corner connection between the east and north façades. Drawing: Mirna Soto, for the GCI.

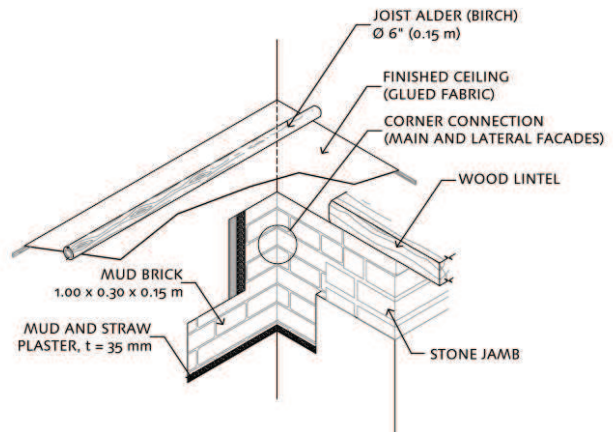

end of this wall is in part constructed with stone masonry (see prospection IS-1, Fig. 6.21). The walls in sector 1 are approximately 5 m high at the first floor,²⁵ and at the second floor, the walls measure approximately 4 m to the eaves and 5.5 m to the top of the gable. Sectors 2 and 5 have similar height walls; although, due to the natural slope of the site, the first floor walls are somewhat shorter at 4 m. The infill walls in sector 3 are somewhat thinner, ranging in thickness from 0.60 to 0.90 m.

The mud bricks are set in an English bond pattern, with alternating courses of header and stretcher bricks.²⁶ A typical mud brick measures 0.75 m long \times 0.30–0.35 m deep \times 0.15 m high and is reinforced with straw. The bricks are laid in a mud and straw mortar, with both horizontal and vertical mortar joints ranging in thickness from 20 to 25 mm. At both the first and second floors of sectors 1 and 2, the corners of the mud brick walls are connected through overlapping bricks (Fig. 6.23).

Due to the plan configuration and lack of transverse walls in some locations, there are several relatively long spans of unrestrained mud brick construction. In sector 1, there are two large rooms at the second floor, measuring 5.2 m wide \times 11.2 m long (room A-203) and 5.2 m wide \times 13.2 m long (room A-204). The 27.2 m long east façade at the east side of these rooms is braced only by the gable end walls and one interior transverse wall. Similarly, in sector 2, there are three small rooms at the second floor; and, the overall span between the mud brick walls at either end of the sector is 15.7 m. Rooms C-200 and C-201 are divided by a quincha partition, and rooms C-202 and C-203 are divided by a thin mud brick wall. Neither of these partitions is properly connected to the north façade. In sector 5, the 13.5 m long south perimeter wall, which abuts the adjacent property, was originally constructed without intermediate bracing. At both the first and second floors of sector 5 only a few thin mud brick or quincha partitions are set perpendicular to the south perimeter wall. There has been some attempt to reinforce the south perimeter wall in this sector, through the installation of threaded steel bar anchors with wood plates, connecting it to the wall of the adjacent building (see section 6.6 for further description).

The first and second floor openings do not necessarily align in plan. There are significant lengths of continuous, uninterrupted vertical wall panels at the east façade along Calle Arones, which has three shop doors and a large double entry

door at the ground floor and four openings providing access to exterior balconies at the second floor. At the north façade along Calle Nueva Alta, there are no openings in the sector 1 gable wall. In sector 2, there are three small openings at the first floor and three larger openings at the second floor. The first and second floor openings at sector 2 do not align, thus reducing the width of uninterrupted mud brick panels at the façades. As sector 4 is divided into a number of small rooms, there are a significant number of door openings within the mud brick walls. Sector 5 abuts an adjacent mud brick building, and thus there are no openings within the south wall. In all sectors, closely-spaced wood lintels are typically used to span the openings. The ratio of openings to the vertical surface area of the façades is provided in Table 6.1.

Both the exterior and interior sides of the mud brick walls are finished with a mud and straw plaster. Cement plaster has been applied around the exterior side of the door opening to room A-102 along Calles Arones. The exterior plaster has a non-decorative painted white finish. The interior rendering typically consists of one 20 to 30 mm thick layer of a mud and straw plaster and one layer of 2 mm thick gypsum; however, the thickness is greater where later plaster coats have been applied over the original coat.

Table 6.1: Ratio of openings to total vertical surface area of façades

Façade	Area of Openings*/Total Vertical Surface Area of Façade
East façade, along Calle Arones	13%
North façade, sector 1, along Calle Nueva Alta	0%
North façade, sector 2, along Calle Nueva Alta	15%
Exterior façade average	9.3%
North patio façade (fired brick and mud brick wall), sector 2	18%
East patio façade (mud brick wall), sector 4	24%
South patio façade (mud brick wall), sector 5	0%
Patio façade average	14%

* Does not include any infilled openings at the patio façades.

FIGURE 6.24 (LEFT)
First floor arcade at the north side of the patio, with stone columns and fired brick arches (covered with plaster).
Image: Sara Lardinois.



FIGURE 6.25 (RIGHT)
Second floor arcade at north side of patio, with stone columns at stone masonry arches.
Image: Claudia Cancino.



FIGURE 6.26
Prospection IW-2, showing fired brick arch with adobe infill at the north side of gallery 116. The door opening provides access to storage C-109.
Rendering: Jabdriel Zapata, for the GCI.

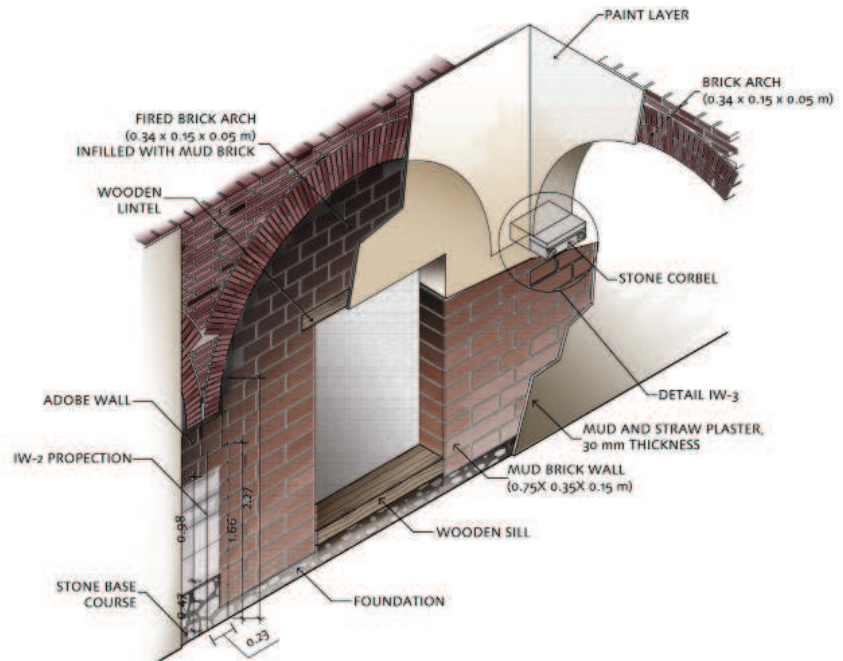

6.5.3.2 Load-bearing fired brick and stone masonry walls

The arcades at the north and south sides of the patio are typically constructed with cut stone masonry with lime mortar; however, fired brick masonry is used for the first floor arches at the north side of the patio. Each arcade consists of four stone or fired brick arches at the first floor and eight smaller stone arches over a low stone parapet at the second floor (Figs. 6.24, 6.25). The arches are supported by stone columns or end brackets embedded in the adjacent mud brick construction. Most of the stone and fired brick is covered with a painted mud plaster; however, the stone columns are exposed. Fired brick arches were also observed within the mud brick wall construction at the north, east, south and west sides of the north gallery (room 116). The arches of the north side were originally open and later infilled with mud bricks (Fig. 6.26).

FIGURE 6.27 (LEFT)
Prospection IIW-3, illustrating the quincha wall construction.
Image: Mirna Soto, for the GCI.

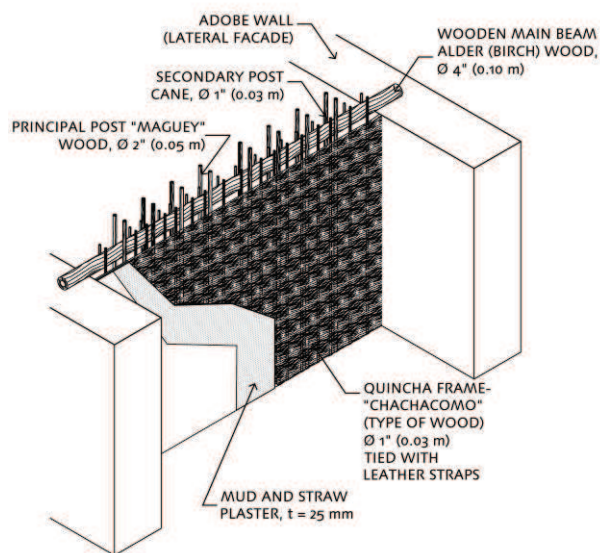

FIGURE 6.28 (RIGHT)
Prospection IIW-3, photographic view of 1" (0.025 m) diameter wood trunks below the mud and straw plaster.
Image: Mirna Soto, for the GCI.



6.5.3.3 Quincha partitions

Quincha is used for interior partitions at the second floor of sectors B2, B4, and B5. The partitions are approximately 0.30 m thick and consist of two adjacent quincha frames. The tops of the frame posts are supported by the wood tie beams at the roof above (Fig. 6.27, 6.28). The primary quincha posts are made of maguey wood, 2" (0.05 m) in diameter, and are spaced at 0.75 m on center. The secondary posts are made of 1" (0.03 m) diameter canes. One-inch diameter, horizontal local *Chachacomo* tree trunks or branches are attached to the posts with leather straps and are covered with a mud and straw plaster. The frames themselves are not structurally connected to the lateral mud brick walls, except for the fact that the tops of the posts are attached to a roof tie beam with ends that are embedded in the walls.

6.5.4 Floors

Constructed on grade, the first floor is finished with a number of different materials installed directly over the ground or fill. The second floor construction is comprised of a 0.04 m thick layer of lime, sand, and gypsum mortar, followed by a 0.03 m thick layer of straw with some mud in it, over 1" (0.025 m) diameter *Chachacomo* tree trunks or branches, supported by 6" (0.15 m) diameter wood joists spaced approximately 0.50 m on center and pocketed into the mud brick walls. The *Chachacomo* trunks are tied to one another and the floor joists with leather straps (Figs. 6.29, 6.30). At rooms having a long span between the lateral walls, such as in sector B1, overlapping joist ends with an east–west orientation are supported by 8" (0.20 m) diameter wood beams or girders with a north–south orientation (Fig. 6.31). These beam or girder ends are pocketed into the mud brick walls. The underside of the framing and canes is finished with thin coat of gypsum plaster. Second floor finishes include the exposed lime and sand mortar finish coat, stone pavers, ceramic tiles, and wood planks. Cantilevered corridors and balconies are constructed using 0.03 m thick wood planks over wood framing and 0.07 × 0.17 m hand-sawn wood posts support the roof framing above (Fig. 6.32).

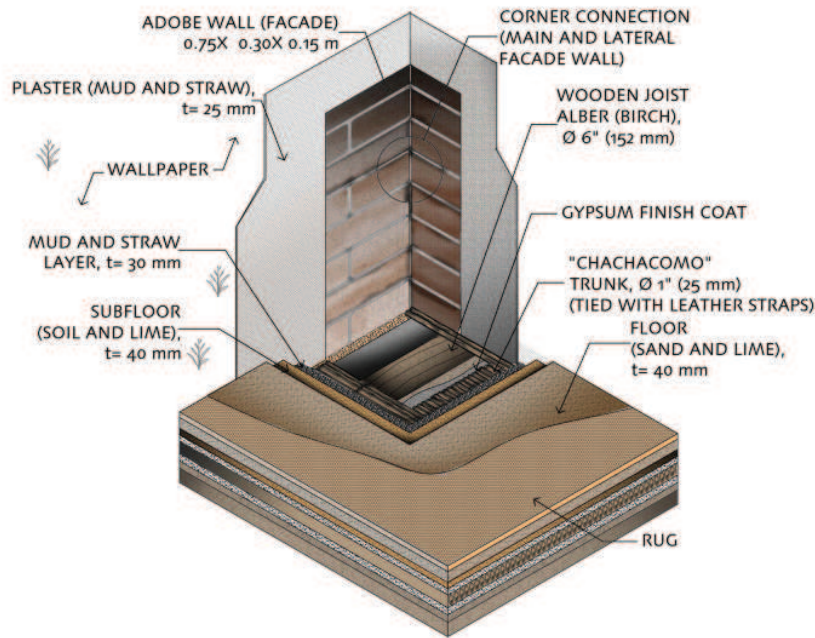

FIGURE 6.29
Prospection IIW-2, showing the second floor construction at the southeast corner of room A-204.
Rendering: Jabdriel Zapata, for the GCI.



FIGURE 6.30
Prospection IIW-1, photographic view of floor construction at the northeast corner of room A-203.
Image: Claudia Cancino.

FIGURE 6.31 (LEFT)
View of room C-109 ceiling, showing wood beam or girder, running in the east-west direction and supporting the floor joists above.
Image: Sara Lardinois.



FIGURE 6.32 (RIGHT)
View of wood framing at cantilevered balcony at east side of patio.
Image: Sara Lardinois.



6.5.5 Roof

Sectors 1 and 2 of Casa Arones are covered with gable roofs set at right angles to one another and each having an approximate slope of 4:12. The galleries in sectors 2 and 4 are covered by extensions of the main gable roof slopes. Sector 5 is covered by a shed roof that slopes downward towards the patio. Each of the different roofs is constructed with wood framing and covered with *Kur Kur* canes,²⁷ a mud and straw layer (*torta de barro*), and Spanish style terra cotta roof tiles.²⁸ Where the roof framing is exposed, such as at the galleries surrounding the patio, the underside of the framing is covered with a gypsum finish coat.

The framing at the gable roofs consists of wood *pares y nudillos* framing, which are trusses composed of two rafters and a collar tie connected with leather straps, spaced at 1.1–1.2 m on center. Two intermediate rafters typically occur between each pares y nudillos truss, and a 4" (0.10 m) diameter tie beam occurs approximately every 3.50 m (Figs. 6.33, 6.34). The tie beam and rafters extend into the mud brick wall construction approximately 0.15 m. A short joist, or lookout, is tied to the end of the tie beam and projects beyond the exterior wall to form the eaves. The ends of the rafters sit on discontinuous wood plates embedded within the mud brick walls. Wall plates were observed in room C-200 of sector B2; however, inspections IIC-1 and IIC-2, carried out in room A-204 of sector B1 did not reveal the presence of wall plates (Fig. 6.35). The rafters are strapped to a wood ridge beam which is supported by the gable end walls. The finished flat ceiling in Sectors 1 and 2 is either directly attached to the underside of the tie beams or is hung from a secondary wood framing system. The roof over the galleries and in Sector 5 utilizes a similar framing system to that of the gable roof, but without a collar tie (Figs. 6.36–6.38). Wood keys are used where the roof tie beams intersect with the stone masonry gallery arcades (Fig. 6.39). A wood key was also observed at the north wall of gallery 210.

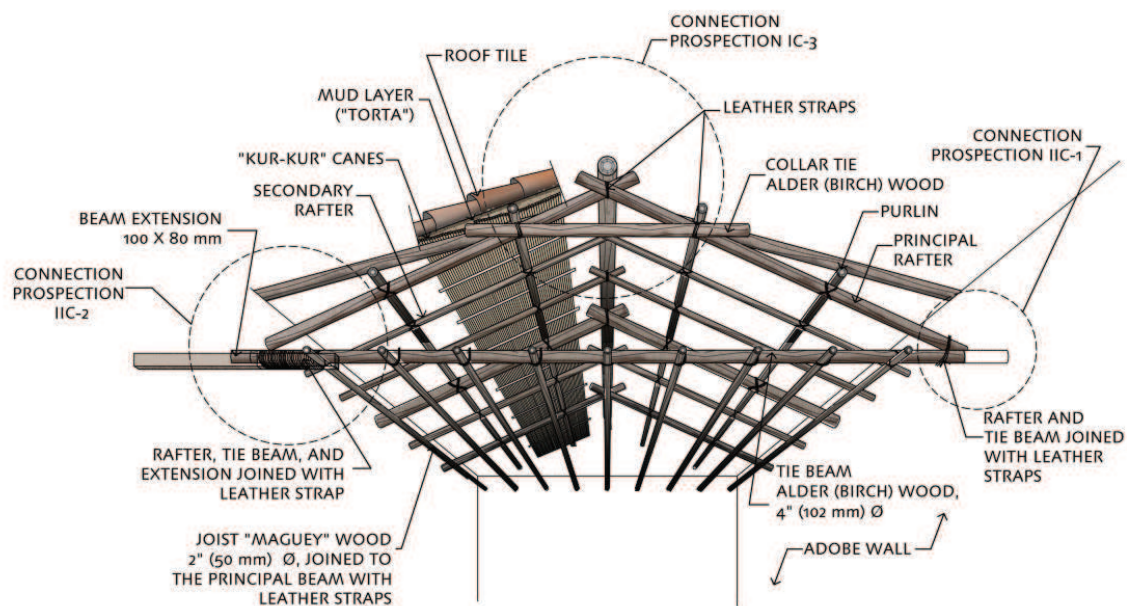

FIGURE 6.33

Inspections IIC-1, IIC-2, and IIC-3, showing the roof structure over sector B1, with rafters, collar ties, and tie beams. Rendering: Jabdiel Zapata, for the GCI.

FIGURE 6.34 (LEFT)
Prospection IIC-2, photographic view of tie beam end at mud brick wall (at left), with ceiling joist below.
Image: Mirna Soto, for the GCI.



FIGURE 6.35 (RIGHT)
View of wall plate below roof rafters, room C-200.
Image: Sara Lardinois.

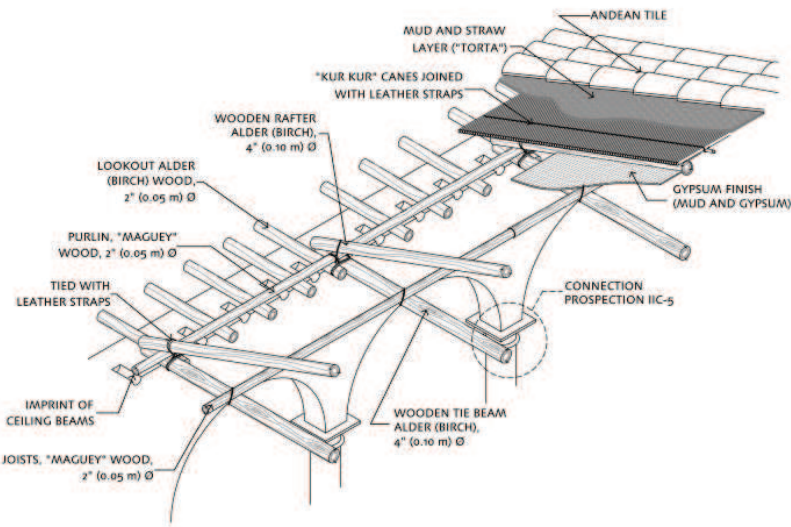
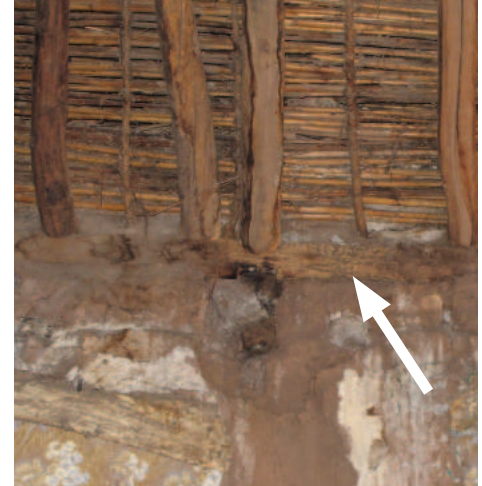

FIGURE 6.36
Prospection IIC-6, illustrating roof framing over the north gallery 210, sector B2.
Drawing: Mirna Soto, for the GCI.



FIGURE 6.37
Exposed rafters at ceiling of gallery 210
Image: Sara Lardinois.

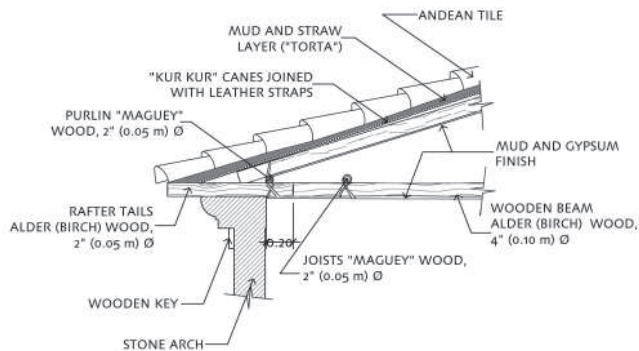

FIGURE 6.38
Prospection IIC-4, illustrating roof framing over the cantilevered wood balcony, sector B4.
Drawing: Mirna Soto, for the GCI.



FIGURE 6.39
Wood key at intersection of tie beam and arcade wall, north side of patio.
Image: Carina Fonseca.

6.6 Irregularities, Alterations, Damages, and Decay

The following sections describe the current condition of the different structural materials, elements, and systems making up the Casa Arones and any irregularities, alterations, damages, and decay that were visually observed during the construction assessment survey.

6.6.1 Foundations and base course

Overall, the foundation and base course are in fair condition and generally cohesive. Humidity in the soil and foundations and rising damp have led to moisture damage, detachment and loss of plasters, and basal erosion at some of the mud brick walls above. At the north façade (sector A2) there has been severe erosion and loss of the base course stones in an area corresponding to room C-109. The damage is most severe below the window in that room (Figs. 6.40, 6.41). This damage may be the result of falling water from the roof above, as the location corresponds to the valley at the intersection of the two main gable roofs. Surface water runoff along the adjacent sloping sidewalk, which is finished with smooth impermeable stone paving, may also contribute to the problem; however, this is an unlikely source as the damage is localized and is not as severe in other parts of the north elevation.

6.6.2 Walls

6.6.2.1 Load-bearing mud brick masonry walls

Due to the plan configuration and lack of transverse walls in some locations, there are several relatively long spans of unrestrained mud brick construction at the second floor, which increases the vulnerability of the walls to out-of-plane failure mechanisms. Where transverse walls are more prevalent, such as in sector B2, they are not properly connected to the north façade wall; and as a result they do not effectively improve the out-of-plane behavior of the north façade. Vertical cracks



FIGURE 6.40
Erosion and loss of base course stones outside room C-109, north façade.
Image: Claudia Cancino.

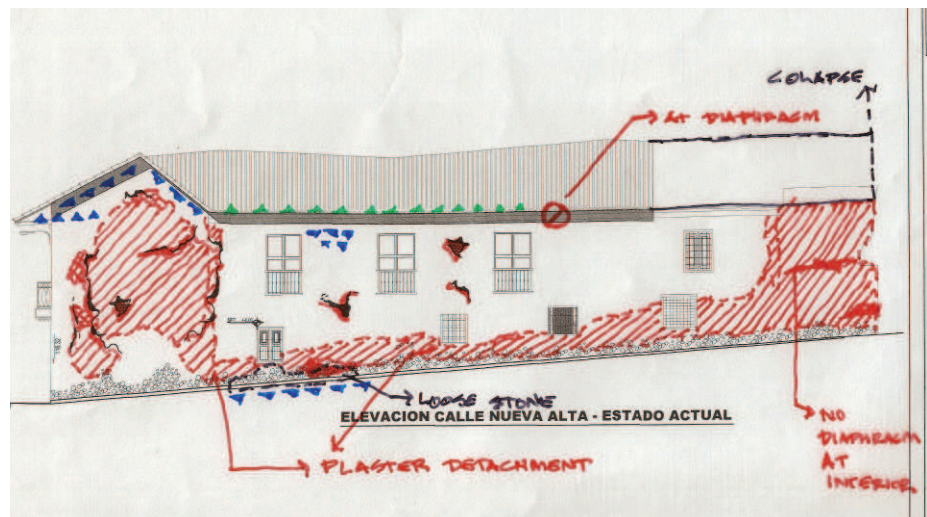

FIGURE 6.41
Graphic condition survey of north façade, indicating areas of loose and lost base course stones (in black) and plaster detachment (in red). Areas of moisture damage are indicated with the blue triangles, and green triangles mark areas where vegetation is present.
Drawing: Claudia Cancino.

were observed in the transverse walls, suggesting some out-of-plane displacement in the lateral perimeter walls in both sectors B1 and B2 (Fig. 6.42). In room 204 of sector B1, a significant diagonal crack was observed through prospection IIW-2, indicating some disconnection between the façade at Calle Arones and the south perimeter wall (Fig. 6.43). In sector B5, At the south wall, five 5/8" (16 mm) diameter threaded steel rods with steel plates and wood blocking have been installed at the second floor, tying the south wall to the adjacent building wall; however, this is not a good solution because stress concentrations produce cracking around the rod (Fig. 6.44).

The mud brick walls are in fair condition overall. Rising damp and a leaking roof have led to detachment and loss of the interior wall plasters and erosion of the mud brick construction at the base and tops of many walls. The basal erosion is most significant at the southwest corner of sector A1. Although the walls do not appear to be unstable as a result, the erosion has led to failure of some of the connections between the roof framing and walls. The basal erosion may compromise the structural performance of the mud brick walls in future seismic events.

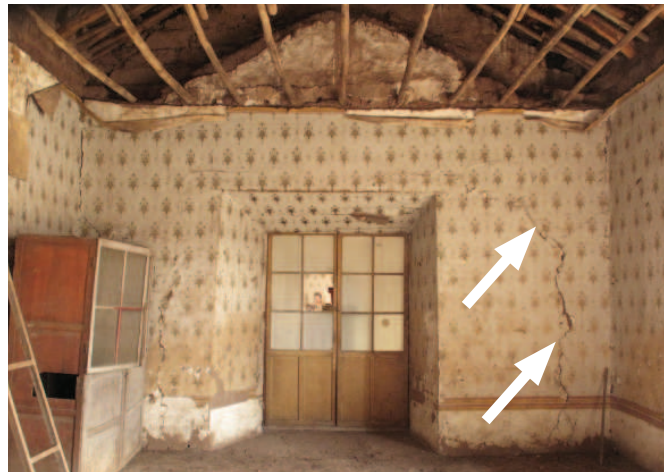

FIGURE 6.42
Vertical crack in transverse wall between rooms A-203 and A-204, adjacent to the east façade.
Image: Claudia Cancino.



FIGURE 6.43 (LEFT)
Crack in second floor mud brick wall at southeast corner of building, indicating a disconnection between the façade at Calle Arones and the south perimeter wall.
Image: Claudia Cancino.



FIGURE 6.44 (RIGHT)
Threaded steel rod, plate, and wood blocking at south perimeter wall (room B-206).
Image: Sara Lardinois.

Due to lack of maintenance, the exterior plaster covering has been partially lost, leaving the mud bricks exposed in many locations. The loss is most severe along the north façade (Fig. 6.41). At the interior, the plaster remains intact; although there are areas of plaster detachment and loss at the base and top of walls, resulting from the rising damp and moisture damage previously described.

6.6.2.2 Load-bearing fired brick and stone masonry walls

The fired brick and stone masonry arcades are in poor condition and unstable (Fig. 6.45). While the stones themselves are in good condition, there is significant loss of mortar. The arcade walls have long spans, which are poorly restrained. As a result, they exhibit some outward displacement and the arches themselves were in danger of collapse prior to the installation of a temporary shoring system. The west ends of both the north and south arcade walls appear to be the most unstable, with cracking and separation between the stones (Fig. 6.46). This may also be the result of displacement in the adjacent mud brick wall at the west side of the patio, brought on by the collapse and demolition of the adjacent construction. Portions of the second floor arcade at the south side of the patio have been infilled with mud bricks (Fig. 6.47).

6.6.2.3 Quincha partitions

The quincha panels are in good condition.

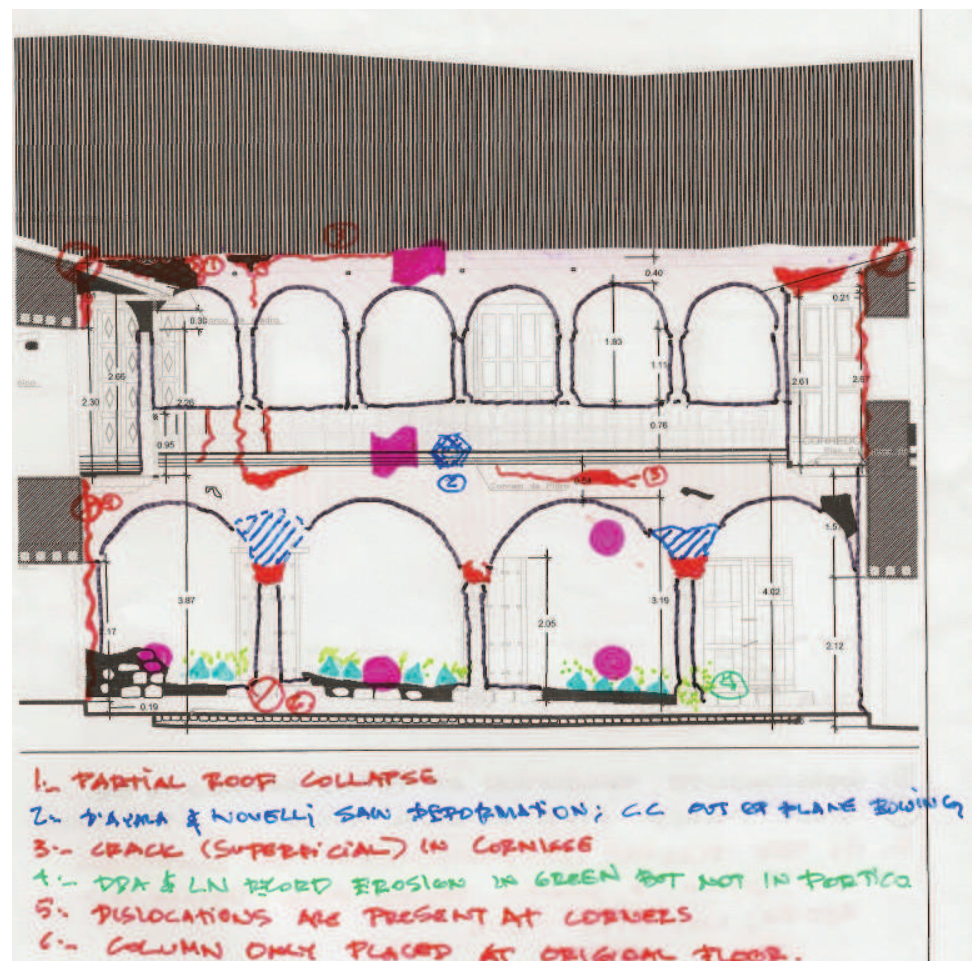

FIGURE 6.45

Graphic condition survey of fired brick and stone masonry arcade wall at the north side of patio.
Drawing: Claudia Cancino.



FIGURE 6.46
West end of stone masonry parapet wall at south arcade, as viewed from room B-206.
Image: Sara Lardinois.



FIGURE 6.47
View of infilled arcade at south side of patio.
Image: Sara Lardinois.

6.6.3 Floors

The floors have been subject to a number of alterations including:

- It appears that there was once an exterior balcony wrapping the northeast corner of the building; however, this was removed and some point and only the remnant sawn-off beam ends embedded in the wall remain.
- A wood-framed second floor corridor was constructed at the east and west sides of patio, linking the north gallery (sector A2) with south addition (sector A5).
- A wood-framed mezzanine was constructed within commercial space A-102 (sector A1).

The second floor finishes and framing are in fair to poor condition. A leaking roof has led to uneven settlement, significant loss of the mortar layer in some locations, and rot and deformation of wood floor joists and beams below. This damage is most pronounced at the far south end of sector A1 and in sector A5, corresponding the area of greatest roof damage above. In areas where the gypsum plaster at the underside of the wood floor joists and beams has been lost, beetle damage was observed.

6.6.4 Roof

The roof covering has been replaced at least once in the building's history; however, it appears that only damaged wood rafters and trusses have been replaced as needed, with some of the original framing remaining.

The roof is in poor condition. The following decay and damages were observed:

- There are several large areas of missing roof tiles, which have been patched with corrugated metal sheets.
- Water infiltration through the roof has led to detachment and loss of interior wall plasters, erosion at the tops of the mud brick walls, and damage to the second floor ceiling finishes and framing below:

FIGURE 6.48
View of broken collar ties.
Image: Sara Lardinois.



- As a result, a large percentage of the second floor ceiling joists and plaster finish has collapsed or been intentionally removed due to its poor condition.
- The gypsum plaster ceiling finish at the underside of the roof rafters in sector B5 and other second floor galleries and porches is in poor condition, with large areas of loss.
- In some cases, the depth of erosion at the top of the mud brick walls is so great that the ends of the roof rafters and tie beams are no longer supported by the walls.
- Wood rot and beetle damage were observed in some of the wall plates and wood framing.
- At several pares y nudillos trusses, the connection between the collar ties and rafters has failed, and the collar ties are deformed or broken (Fig. 6.48).

As a result of these conditions, the roof is unable to fully resist thrust actions and is partially collapsed. The degree of collapse is greatest at the south end of sector B1 and the west end of sector B2. The deformation and collapse has given the roof an irregular profile.

6.6.5 System-wide irregularities, alterations, damages, and decay

Casa Arones has been subject to a number of system-wide alterations; however, the extent and chronology of these alterations is still unclear after review of the extant historic research and numerous investigative inspections. Possible and known alterations include:

- Originally, there may have been a gallery at the east side of the patio (sectors A4 and B4), which was later infilled with earthen construction to create multiple small rooms that currently exist at the first and second floors between the patio and original construction along Calle Arones. Presumably, the wood-framed second floor corridor at the east side of the patio was constructed at the same time. Alternatively, all of sectors A4 and A5 may represent a later addition to the building.
- The house is thought to have originally had a staircase near the northeast corner of the house; however, the most recent staircase at the west side of the patio has collapsed or been dismantled due to damages. At the pres-

ent time, a temporary wood plank ramp in the garden is the only means of access between the first and second floors.

Casa Arones has also been subject to a number of system-wide damages and decay, including:

- A wood shoring system has been installed throughout the building as an emergency intervention to support the stone masonry arcades surrounding the patio and the failing floor and roof framing elements.
- The rear western wing (not part of this construction assessment), surrounding the second patio, has collapsed.

6.7 Preliminary Findings

The following preliminary findings on the structural behavior of Casa Arones are based upon qualitative methods, including historical research and direct observations made by the investigative team during surveys carried out in 2010. The investigative team utilized their past experience with historic earthen construction to interpret that data collected through research and observation and develop preliminary ideas on the possible structural behavior of the building. These preliminary findings will be explored further in the next phases of the project through quantitative methods, including static and dynamic testing and numerical modeling analyses. Following the quantitative testing and analyses, the preliminary findings will be revised as necessary and expanded upon to provide a complete diagnosis and safety evaluation.

The preliminary findings are:

- Casa Arones is in fair to poor condition overall. Most observed damages are the result of lack of maintenance.
- The structural performance of the building is compromised by several unstable elements, including the fired brick and stone masonry arcades and the roof structure.
 - The arcade arches are unstable due to the fact that there is not any bracing for the columns that support the arches. The low resistance of the lime mortar used in the masonry further contributes to the instability of the arcades.
- The leaking roof has damaged the tops of the walls and the connections between the roof and the walls. This damage has a negative impact on the out-of-plane bracing that is provided by the tie beams.
- Basal erosion in the walls is the result of a leaking roof, the lack of an efficient drainage system, and humidity in the soil.
- There are relatively few transverse walls at the second floor; and, where present, there is often a disconnection between transverse and lateral walls. This has led to outward displacement and vertical cracking.
- The shear cracking, including the cracks the corners of openings, is a result of the low resistance of mud brick construction to tensile stresses.

Notes

- 1 Cusco was declared the Historical Capital of Peru in the Peruvian constitution of 1993.
- 2 Rostworowski de Diez Canseco 1962, 132. According to Rostworowski de Diez Canseco, this sector of Cusco was devoted to the cultivation of potatoes, corn and “quinua.”
- 3 The historian and author Garcilaso de la Vega (1539–1616) wrote of the andenes in this area, “La tierra que araban era un andén hermosísimo que esta encima de donde esta fundado el convento del señor de San Francisco, La casa cual digo que es el cuerpo de la iglesia, labro a su costa el dicho Juan Rodríguez y Villalobos a devoción del señor de San Lázaro cuyo devotísimo fueron los frailes franciscanos.” Quoted in Vega 1959, 218.
- 4 Calle del Hospital, Calle Nueva Alta, and Calle Nueva Baja were laid out according to the pre-existing pattern of the andenes walls.
- 5 The Picchu sector of Cusco included the neighborhoods of Carmenca and Quillapata. Vega noted “Yendo con el mismo cerco, yendo al poniente hacia el norte había otro barrio llamado Picchu. También estaba fuera de la ciudad. Delante de este siguiendo el mismo cerco, esta el gran barrio llamado Carmenca, nombre propio y no de la lengua general. Por él sale el camino real que va al Chinchaysuyo.” Quoted in Vega 1959, 42–46.
- 6 It was considered the fifth *huaca* (sacred place or monument) in the ninth *ceque* (line or pathways connecting shrines), towards the Chinchaysuyo, which was the Northern region of the Tahuantinsuyo (Rowe 1981). Tahuantinsuyo, a Quechua word meaning the *four quarters* or *portions*, was the name used by the Incas for their territory and that is presently referred to as the Inca Empire. The Chinchaysuyo included the Western part of Cusco and the current Peruvian province of Caraveli in the Arequipa region along the coast and extended North to Pasto (in present day Colombia), including all the territories in present day Ecuador.
- 7 The origin and meaning of the Incan name Chacuaytapara is unknown.
- 8 An *ayllu* is an extended family group that formed the basic political and social units of pre-Inca and Inca life in the Andes
- 9 According to historian and author Garcilaso de la Vega, at the beginning of the seventeenth century, the city of Cusco extended as far as Chaquillchaca (Vega 1959).
- 10 Esquivel Coronado 2001, 35.
- 11 In the side chapel of the Cathedral of Cusco, a famous painting by Alonso Cortés de Monroy, known as the Monroy Panorama, depicts the city of Cusco immediately following the 1650 earthquake.
- 12 In this map, *El Plano Más Antiguo Del Cusco, Dos parroquias de la ciudad vistas en 1643*, which is located in the Archivo Arzobispal de Lima, the notes surrounding Casa Arones read: “Panadería del tesorero Gueuara/ Martín Rivera / Franco Aluares tintorero Baltasar González arriero” (“Bakery of treasurer Gueuara /Martín Rivera / Franco Aluares dyer Baltasar González mule driver”).

13 The research carried out by Juan Carlos Miranda Cárdenas and Gonzalo Paiva Villafuerte provides an excellent history of the chain of title for Casa Arones. A summary of their research is provided in the table below:

DATE		OCCUPANTS		REFERENCES
XVII	1651	Owner	Pedro Carrasco	ADC. en Salvador Meléndez, pag. 624
	1656	Owner	Bartolomé Palomares	ADC. en Meza Andueza, pag. 653
XVII	1682–1773	Owner	Cipriano Oblitas	Ramón Gutiérrez, pag. 195 AMSC. Libro de censos, vol. 01
	1773	Owner	Alberto Capetillo Fray Miguel de Sierro	Ramón Gutiérrez, pag. 195
		Owner	Esteban de Alzamora	
		Owner	Antonio Alzamora y de la Fuente	
	1794	Owner	Melchor Gómez Bustamante	ADC. En Rodríguez Ledesma 1744, fol 427
	1795	Owner	Antonia Alzamora	ADC. en Bernardo J. Gamarra, pag. 103
1798	Owner	Mateo Aguinaga	Ramón Gutiérrez. <i>La casa Cusqueña</i> , pag. 195	
XIX	1811	Tenant	Juan Clemente Jordán	Ramón Gutiérrez. <i>La casa Cusqueña</i> , pag. 195
	1820	Owner	Gaspar Castillo	
	1822-1823	Owner	Benigno Peralta	AMSC. Libro de censos 1833
	M. 1800	Owner	Casimiro del Castillo	ADC. Toribio Constantino Alosilla
	18xx-1897	Owner	Isabel Alcázar y Don Silvestre Cáceres	ADC. Toribio Constantino Alosilla

Source: Miranda Cárdenas and Paiva Villafuerte n.d., 44.

- 14 On the topic of settlement patterns and building typologies, Juan Carlos Miranda Cárdenas and Gonzalo Paiva Villafuerte write: "En el Cusco se distingue dos patrones de asentamiento; las viviendas asentadas sobre las kanchas Incas y las que se ubicaron en áreas de expansión (terrenos agrícolas), de estas últimas el Arquitecto Ramón Gutiérrez hace mención que el amanzamiento parece haber subdividido en cuatro solares a la manera española mientras que el Padre Antonio San Cristóbal menciona que para la arquitectura de las casas cuzqueñas, los primeros constructores españoles encontraron ya dispuesto en las kanchas incaicas el patio central, las crujías de base aprovechables al menos para la crujía frontera de la calle. y un vano de entrada en un costado de la fachada fácilmente transformable en el insustituible zaguán de las casas virreinales. El aprovechamiento de estas estructuras simples pre-hispánicas requirió ya desde el comienzo de la urbanización española en el Cusco el despliegue de una actividad creadora para adaptar las formas tradicionales hispánicas de vivienda a los condicionamientos concretos locales, que se pretendían aprovechar." Miranda Cárdenas and Paiva Villafuerte n.d., 20.
- 15 The drawing, from the Archivo Arzobispal del Cusco, is reproduced in Esquivel Coronado n.d., 24.
- 16 Cusco is inscribed on the World Heritage list with its alternate spelling of Cuzco.
- 17 The rear wing and garden are not further described in this section, nor are they included in building dimensions or area calculations.

- 18 The area calculation includes the open air central patio. The garden wing at the rear of the building is not included in the area calculation, as it is not part of this structural assessment.
- 19 During the period of the Spanish Viceroyalty in Peru, arched entrances were reserved for religious buildings; and, thus, only flat lintels could be used for secular building entries (Fraser 1990, 123).
- 20 Seismic zones are defined in Capítulo II, Parámetros de Sitio of the *Norma Técnica de Edificación E.030: Diseño Sismorresistente*, which is available online at http://www.igp.gob.pe/web_page/images/documents/ltorres/norma_tecnica_edificaciones.pdf.
- 21 Information on earthquake dates, epicenter locations, and moment magnitudes (M_w) is summarized from United States Geological Survey (USGS) Historic World Earthquakes, Peru, http://earthquake.usgs.gov/earthquakes/world/historical_country.php#peru. Estimates of moment magnitudes for the 1943 Yanaoca, 1913 Abancay, 1746 Lima, and 1650 Cusco earthquakes are not available in the summary.
- 22 Construction date based upon the chronology provided on architectural drawing sheets EA-01 and EA-02, which are part of the Restauración y Rehabilitación de la Casa Arones, "La Casa de la Hispanidad Andina" project drawings prepared for C.E.G. Guamán Poma de Ayala by Architects Enrique Estrada and Yisela Ochoa Lind and dated January 2005.
- 23 Ibid.
- 24 Criteria for determining slenderness ratios are based upon those provided in Tolles, Kimbro, Webster, and Ginell 2000.
- 25 Wall height measurements are given from finish floor to finish floor. The height of the actual mud brick construction is somewhat less, as it sits on a 0.55–1.50 m high base course.
- 26 The term *English bond* is a common English-language term to describe a type of masonry bond pattern.
- 27 *Kur Kur* is a type of highland bamboo that is commonly used for roof coverings in the Cusco region. The canes are thin and without voids in the center.
- 28 The term *Spanish style* is used to describe roof tiles having a semi-cylindrical shape and are laid in alternating courses so that a tile with a convex side up is adjacent to and interlocking with a tile having its convex side down.

Conclusions

7.1 Conclusions after the Assessment

The data collected for this assessment report is now being used for the development of the proposals for the numerical modeling and seismic analyses and the complementary experimental tests for the four historic earthen prototype buildings. Although this work is in progress, it is possible to make some general conclusions regarding the survey methodology and the collected structural data, as well as some preliminary conclusions regarding the observed structural behavior of the prototype buildings.

7.1.1 Conclusions regarding the survey methodology

- The survey forms developed for the project should be revised as necessary to include any missing data that is needed for the numerical modeling and seismic analyses and corresponding static and dynamic testing. The revised forms should be disseminated to Peruvian colleagues for use as a tool to structurally assess other earthen buildings. Eventually, these forms could be further modified to suggest and prioritize retrofitting interventions.
- Thorough building documentation is necessary to fully understand a building and its structural components. The architectural floor plans, elevations, sections, and particularly the annotated detail drawings illustrating the structural connections between roofs, walls, and foundations are providing critical structural data for the project. Conclusions related to the documentation methodology and resulting uses are as follows:
 - The prospection process, which methodologically opened up the buildings without causing damage to the sites, was necessary to create the annotated detail drawings. When determining which areas of a building to open up, it is important to strike a balance between what type of data is desirable to attain and what is feasible to obtain and will not jeopardize the integrity of the site. Engineers or other professionals who will use the data should be involved in the selection process, providing a detailed list of the critical areas to be explored; the type of data to be recorded, including any requirements for the amount and accuracy of recorded dimensions; and the requirements for the format of the resulting documentation—drawings, photographs, or video. Ideally, the data users should also be on site when the prospectations are carried out (Figs. 7.1–7.4).
 - The architectural plans and prospection drawings are proving to be useful for the creation of the numerical model of each prototype building. However, as the prospection drawings only illustrate portions of the

FIGURE 7.1 (NEAR RIGHT)
Prospection process: workman opening up the second floor at Casa Arones.
Image: Sara Lardinois.



FIGURE 7.2 (FAR RIGHT)
Prospection process: project team engineers inspecting the opened floor area at Casa Arones.
Image: Sara Lardinois.



FIGURE 7.3
Prospection process: project team documenting the roof connections at the Cathedral of Ica, taking advantage of those areas made visible by the previous collapse of portions of the roof.
Image: Mirna Soto, for the GCI.



FIGURE 7.4
Prospection process: supervising architect narrating a video documenting what was discovered through a foundation prospection at the Church of Kufio Tambo.
Image: Claudia Cancino.

buildings and it is not feasible to open up an entire building, there have been some questions about what is appropriate to assume regarding the construction of the entire building. Similarly, even in those portions of the building that are opened up, it is not always possible to obtain dimensions for every connection, such as the size of dowels or tenons. This has also led to questions about what is appropriate to assume. Where possible, assumptions have been made based upon the project team's knowledge of historic construction techniques in Peru. The list of critical information mentioned above should also describe the permissible assumptions that can be made when additional information is desired, but not feasible to obtain, and the risk factors associated with making these assumptions.

- In addition to providing critical structural data for the project, the prospection methodology appears to have other valuable and further-reaching results. This method could be disseminated to other Peruvian

colleagues working in the field of earthen site conservation as a means of investigating and studying a site.

- After initial on-site trials, thermal imaging was found to hold potential for nondestructive investigation of earthen sites. In particular, thermal imaging was able to reveal structural information that was not possible to obtain through visual observation only, thus supplementing the information obtained through the limited number of prospections. Many additional nondestructive investigation methods are available and may provide viable options for surveying earthen buildings. Ground penetrating radar, portable X-ray, and sonic pulse transmission are a few of the techniques that could be researched further for possible use in this project or others. The availability of instrumentation and expertise in Peru seems to be the limiting factor; but, if they can be found it would be interesting to see what types of information these investigation methods could produce when used on earthen buildings (Fig. 7.5).

7.1.2 Conclusions regarding the collected structural data

- The selected prototype buildings have proven to be more structurally complex than originally anticipated. As a result, uncertainties have been identified in the collected structural data which have required that assumptions be made about each of the buildings:
 - **Hotel El Comercio:** Through the prospections, the location, size, and spacing of wood quinchas posts, diagonal bracing, and floor joists and beams were recorded; however, they were not found to be uniform. When constructing the numerical model of the entire building, the post dimensions, the distance between posts, and the presence of diagonal bracing has been generalized.
 - **Cathedral of Ica:** The spacing of the wood framing arches at the barrel vault and domes is irregular. As was done for Hotel El Comercio, the spacing will be standardized in order to develop the numerical model. Given the complexity and scale of the cathedral, the project will focus its study the central bay of the building, including its lateral walls, pillars,

FIGURE 7.5

The prospections were supplemented by thermal imaging, which revealed structural information that was not possible to obtain through visual observation alone.

Image: Mirna Soto, for the GCI.



barrel vaults, and central dome, and then extrapolate the results to the entire structure.

- **Church of Kuño Tambo:** Despite the fact that the walls do not have flat surfaces, the project assumed the contrary in order to build the numerical model. The wall thickness varies across the height of the wall; however, they were standardized for the purposes of the model. The model uses the thickness of the walls provided on the architectural floor plans—and taken at only one vertical elevation—for the entire height of the walls. Ideally, it would have been preferable to have different plans prepared to illustrate the wall thicknesses at different levels; but as this data was not collected, the assumptions noted above have been made. As with the walls, the floors are not level either. A standard floor height was used for each of the different sectors when building the model.
- **Casa Arones:** The construction sequence of Casa Arones is still unclear after a review of the extant historic research and numerous investigative prospections. For the purposes of the project, it has been assumed that the original construction included the stone masonry arcades at the north and south sides of the patio and the wood balconies at the east and west sides of the patio are later additions.
- The connections between the different elements, such as roof–wall, floor–wall, wall–wall (either L or T joints), and foundation–wall, are critical and must be well-documented and understood. When possible, prospection openings should be used to investigate these connections. Nondestructive investigative methods, such as thermal imaging, have also proven to be effective when obtaining some of this information; however, they are not able to provide detailed information such as the size or number of nails or dowels.
- Special attention must also be given to material decay and deterioration. Criteria must be developed that allows material condition to be factored into the assessment of the strength capacity of the building. The condition of the termite-damaged wood elements at the coastal sites of Hotel El Comercio and the Cathedral of Ica must be considered, particularly when analyzing the structural connections between different wood elements.
- The mechanical and physical characteristics of the soil used in the construction of earthen buildings plays an important role when considering measures to control the decay of a building. The material properties, such as modulus of elasticity, shear modulus, and Poisson’s ratio (including also compression and tensile strength), must be considered when building the model. This information can be obtained through both the collection of field data and experimental tests.

7.1.3 Conclusions regarding the observed structural design and behavior

Although the four buildings studied for this construction assessment represent very different structural typologies, some general observations regarding their structural design and behavior can be derived from this assessment. These observations are subject to revision following the completion of the experimental testing and numerical modeling and seismic analyses. The general observations are as follows:

- When assessing a building it is necessary to accurately define and understand the structural system as it was originally designed to resist the vertical loads resulting from its own weight and the inclined forces resulting from vaults and sloped roof loads.
- In both the coastal and Andean regions, the residential structures have typically been subject to more elective alterations than the religious structures. Alterations to the religious structures have generally been related to the repair or rebuilding of earthquake-damaged or deteriorated portions of the structure. While earth is the predominant wall material in all four buildings, other materials have been introduced through alterations:
 - In the case of Hotel El Comercio and Casa Arones, which have both been subject to multiple alterations related to changes in use, there are a number of different wall materials, including mud brick, fired brick, and stone masonry. In some cases—typically in altered areas— all three materials are used in one wall. Due to their potential effect on a building's structural performance, all of these materials must be identified, tested, and modeled.
 - In the case of the Cathedral of Ica and the Church of Kuño Tambo, the original earthen construction remains as the predominate material for the walls (and roof in the case of the Cathedral of Ica). If alterations or additions were made, in-kind or other compatible materials were used.
- With the exception of the Church of Kuño Tambo, which has a base course bearing mostly on hard rock, the prototype buildings all have shallow to moderately-deep foundations. Despite this, none of the buildings exhibited anomalies or distress that could be attributed to foundation settlement problems. It should be noted that the prototypes are essentially low-rise structures, mainly one or two stories in height, and the dead load, or self-weight of the structures, that is transferred through the foundations to the soil is very low as compared to the design loads for new buildings.
- When assessing a building, it is important to identify structural elements—whether original to the design or later additions—which improve the earthquake resistance of the structural system. The following types of earthquake-resistant elements and systems were identified during the construction assessment:
 - **Hotel El Comercio:** Use of light-weight quincha construction for the walls at the second and third stories, which likely acts as a flexible diaphragm.
 - **Cathedral of Ica:** Thick mud brick walls, with a slenderness ratio of 3, which are considered stable during earthquakes and have a low probability of lateral overturning. Original barrel vault and umbrella domes made of wood arches and plastered cane reed mesh that act as a lightweight roofing system.
 - **Church of Kuño Tambo:** Wood tie beams connecting long thick mud brick lateral walls and exterior buttresses, which potentially reduce lateral overturning.
 - **Casa Arones:** Mud brick walls with interwoven corners and wood tie beams which improve the lateral stability of façade walls.

Bibliography

- Cancino, Claudia, Stephen Farneth, Philippe Garnier, Julio Vargas Neumann, and Frederick A. Webster. 2011. *Damage Assessment of Historic Earthen Buildings After the August 15, 2007 Pisco, Peru Earthquake*. Los Angeles: Getty Conservation Institute.
- Corrales Pérez, María del Carmen. 2010. Hotel Comercio. Unpublished report prepared for the Instituto Nacional de Cultura, Lima, Peru.
- Esquivel Coronado, Jessica. 2001. El Barrio de Nueva Alta-História y Interpretación. Architectural thesis, Universidad Nacional San Antonio Abad del Cusco, Peru.
- Esquivel Coronado, Jessica. n.d. La Parroquia de Hospital de los Naturales en el Cusco Colonial (1572–1821). *Urbana en Línea* 18. <http://www.andrespulido.com/uel/inicio.htm>.
- Facultad Pontificia y Civil de Teología de Lima. 1982. *Tercer Concilio Limense, 1582-1583. Versión castellana original de los decretos con el sumario del Segundo Concilio Limense. Edición conmemorativa del IV Centenario de su Celebración, con una Introducción del P. Enrique T. Bartra, S. J.* Lima: Facultad Pontificia y Civil de Teología de Lima.
- Fraser, Valerie. 1990. *The Architecture of Conquest: Building in the Viceroyalty of Peru, 1535–1635*. Cambridge: Cambridge University Press.
- Gálvez, José. 1943. *Calles de Lima y meses del año*. Lima: International Petroleum Company.
- Hardy, Mary, Claudia Cancino, and Gail Ostergren, ed. 2009. *Proceedings of the the Getty Seismic Adobe Project 2006 Colloquium*. Los Angeles: Getty Conservation Institute. http://www.getty.edu/conservation/publications_resources/pdf_publications/gsap.pdf
- Harth-Terré, Emilio. 1948 [2003]. Los artífices vascos en el Perú Virreinal. In *VIIème Congrès d'Etudes Basques = Eusko Ikaskuntzaren VII. Kongresua = VII Congreso de Estudios Vascos*. 451-54. Donostia [San Sebastián]: Eusko Ikaskuntza. <http://www.euskomedia.org/PDFAnlt/congresos/07451454.pdf>
- ICOMOS. 2003. *ICOMOS Charter: Principles for the Analysis, Conservation and Structural Restoration of Architectural Heritage*. http://iscarsah.icomos.org/content/principles/ISCARSAH_Principles_English.pdf
- Instituto Nacional de Investigación y Normalización de la Vivienda (ININVI). 1987. *Adobe: Norma técnica de edificación E-080, julio 1987*. 3rd ed. Lima: Instituto Nacional de Investigación y Normalización de la Vivienda.

- Jurado, Carolina. 2004. Las reducciones toledanas a pueblos de indios: Aproximación a un conflicto: El Repartimiento de Macha (Charcas), siglo XVI. *Cahiers des Amériques latines* 47: 123-37. <http://www.iheal.univ-paris3.fr/IMG/CAL/cal47-etudes3.pdf>
- Lecca, Jaime, and Michel Piaget. 1974. Iglesias de las Haciendas de San José y San Javier de Nazca. Bachelor's thesis, Facultad de Arquitectura, Universidad Nacional de Ingeniería, Lima, Peru.
- Málaga Medina, Alejandro. 1974. Las reducciones indígenas en el Perú (1532-1600). *Historia y cultura* 8: 141-72.
- Ministerio de Transportes, Comunicaciones, Vivienda y Construcción. 2000. *Adobe: Norma técnica de edificación E.080*. Lima, Peru: Ministerio de Transportes, Comunicaciones, Vivienda y Construcción / Servicio Nacional de Capacitación para la Industria de la Construcción [SENCICO].
- Ministerio de Vivienda Construcción y Saneamiento. 2003. *Norma técnica de edificación E.030: Diseño sismorresistente*. Lima: Ministerio de Vivienda Construcción y Saneamiento / Servicio Nacional de Normalización, Capacitación e Investigación para la Industria de la Construcción (SENCICO). http://www.igp.gob.pe/web_page/images/documents/ltorres/norma_tecnica_edificaciones.pdf
- Miranda Cárdenas, Juan Carlos and Gonzalo Paiva Villafuerte. n.d. Restauración y puesta en valor de la Casa Oblitas. Thesis, Universidad Nacional San Antonio Abad del Cusco, Peru.
- Mitma Montes, Grover J., and Jorge E. Alva Hurtado. 2005. Microzonificación de la ciudad de Ica frente a sismos e inundaciones. http://www.cismid.uni.edu.pe/descargas/redacis/redacis27_a.pdf
- Negro, Sandra. 2001. La arquitectura religiosa rural al sur de Lima durante el barroco final en el Perú. In *Barroco iberoamericano: Territorio, arte, espacio y sociedad*. ed. Ana María Aranda. Sevilla: Giralda. <http://www.upo.es/depa/webdhuma/areas/arte/3cb/documentos/073f.pdf>
- Rostworowski de Díez Canseco, María. 1962. *Nuevos datos sobre tenencia de tierras reales en el Incaico*. Madrid: Corrales.
- Rowe, John H. 1981. Una relación de los adoratorios del antiguo Cuzco. *Histórica* 5 (2): 209–261.
- Tolles, E. Leroy, Edna E. Kimbro, and William S. Ginell. 2002. *Planning and Engineering Guidelines for the Seismic Retrofitting of Historic Adobe Structures*. GCI Scientific Program Reports. Los Angeles: Getty Conservation Institute. http://www.getty.edu/conservation/publications_resources/pdf_publications/seismic_retrofitting.pdf
- Tolles, E. Leroy, Edna E. Kimbro, Frederick A. Webster, and William S. Ginell. 2000. *Seismic Stabilization of Historic Adobe Structures: Final Report of the Getty Seismic Adobe Project*. GCI Scientific Program Reports. Los Angeles: Getty Conservation Institute. http://www.getty.edu/conservation/publications_resources/pdf_publications/seismicstabilization.pdf.
- United States Geological Survey (USGS). 2012. Historic World Earthquakes, Peru. http://earthquake.usgs.gov/earthquakes/world/historical_country.php#peru.

- Vargas Ugarte, Rubén. 1963. *Los jesuitas del Perú y el arte*. Lima, Peru: Librería e Imprenta Gil.
- Vargas Ugarte, Rubén, and Lima (Ecclesiastical Province). Council. 1951. *Concilios Limenses (1551-1772)*. Vol. 1. Lima [Peru]: Tip. Peruana S.A.
- Vega, Garcilaso de la, and José Durand. 1959. *Comentarios reales de los Incas*. Lima: Universidad Nacional Mayor de San Marcos.
- Villa Esteves, Deolinda Mercedes. 2010. Información Histórica sobre la Catedral de la ciudad de Ica, antiguo templo de la Compañía de Jesús, distrito departamento y región Ica. Lima, Peru: Instituto Nacional de Cultura.
- Villacorta Santamato, Luis Andrés. 1987. Iglesias Rurales en el Valle de Lima durante la Colonia (1534-1821). Bachelor's thesis, Facultad de Arquitectura, Universidad Nacional de Ingeniería, Lima, Peru.
- Villacorta Santamato, Luis Andrés. 2005. Reducciones Indígenas en el Valle de Lima. *Arkinka* 121: 36-45.
- Villanueva Urteaga, Horacio, ed. 1982. *Cuzco 1689: Informes de los párrocos al obispo Mollinedo: Economía y sociedad en el sur andino*, Archivos de historia andina 2. Cusco: Centro de Estudios Rurales Andinos "Bartolomé de las Casas.
- Zuidema, R. Tom, and Deborah Poole. 1982. Los límites de los cuatro suyus incaicos en el Cuzco. *Bulletin de l'Institut français d'études andines* 11 (1-2): 83-89. [http://www.ifeanet.org/publicaciones/boletines/11\(1-2\)/83.pdf](http://www.ifeanet.org/publicaciones/boletines/11(1-2)/83.pdf)

Archives

- Archivo Arzobispal del Cusco. Libro de Fábrica e Inventario de Bienes y Alhajas perteneciente al Repartimiento de Quispicanchi. Año 1689.
- Archivo Arzobispal del Cusco. Libro de Fábrica y Cofradía. Rondocan. Año 1767–1783: Registro realizado en el periodo del cura Manuel de la Sota.
- Archivo Arzobispal del Cusco. Libro de Fábrica y Cofradía. Rondocan 1830–1832.
- Archivo Regional del Cusco. Grupo Documentario Cabildos de Cusco. Leg° 83. C 16 Año 1816–1817.
- Archivo Regional del Cusco Grupo Documentario Tesorería Fiscal. Libro de Matriculas de la Provincia de Quispicanchi. Año 1830–1838. Libro 01.
- Archivo Parroquial de Acomayo. Sección Colonia. Libro de Fábrica de la Viceparroquia de Cunutambo. Leg. IX 1, 1,7 1681.

Glossary of Architectural Terms

English - Spanish

aisle	nave lateral
altarpiece	retablo
arch	arco, cercha (when referring to structural framing)
ashlar masonry	aparejo isodomo, mampostería escuadrada
barrel vault	bóveda de cañón
base	zócalo
base course	sobrecimiento
batten	listón
bay	crujía
beam	viga
bearing wall	muro de carga
blocking	taco
bond	aparejo
bonder	perpiaño
bondstone	aparejo de tizón
brace	tornapunta
brick paver	ladrillo pastelero
buttress	contrafuerte
choir	coro
cleat	listón
cloister	claustro
cochlea	escalera de caracol
collar tie	nudillo
colonnade	columnata
column	columna
common rafter	viga de tejado común
corbel	ménsula
cornice	cornisa

course	hilada
coursed masonry	mampostería hilada
cross section	sección transversal
cross wall	muro divisorio
crown post	pendolón
dome	cúpula
elevation	elevación
entranceway	vestíbulo
entry hall	zaguán
facade	fachada
false ceiling	cielo raso
finish	acabado
finish ceiling	falso cielo
finish coat (plaster)	enlucido
flattened cane reed	caña chancada
flooring	pavimento
frieze	friso
girder	viga peraltada
groin valut	bóveda de crucería
gutter	canalón
gypsum	yeso
half lap (joint)	a media madera
hand hewn	azuelada
herringbone pattern	aparejo esquina de pez
hip	lima tesa
jamb	derrame
joint	costura, junta, llaga, nudo
joist	vigueta
lath	tequillo
lathing	enlistonado
leather strap	huasca
lime	cal
lookout	can
lunette	luneta
masonry	mampostería
mortar	mortero

mortice and tenon	caja y espiga, mortaja y espiga
mud	barro
nave	nave central
niche	hornacina
pediment	frontis
peg	clavija
pendentive	pechina
pier	mocheta
pillar	pilar
plan	plano
plaster	tarrajeo
post	pies derecho
principal arch	arco fajón
principal rafter	viga de tejado principal
purlin	correa
rafter	cabrio, pare, viga
reinforcement	armadura
ribbed vault	bóveda de crucería
ridge beam, ridge purlin	cumbrera, viga cumbrera
ridgepiece	parhilera
ring	anillo
roofing	tejado
rubble	escombros, ripio
rubble masonry	mampostería ordinaria
section	sección transversal
shoring	puntales
sill plate	solera, viga collar
site plan	ubicación
sleepers	durmientes
spandrel	enjuta, albanega
Spanish tile	teja árabe o curva
spiral stair	escalera de caracol
splay	derrame
stringer	puente

subfloor	falso piso, falso suelo
terrace	terraza
tie beam	tirante
tongue and groove	machihembrado
transept	transepto
truss	armadura de cubierta
typmanum	tímpano
underpitch vault	bóveda de lunetos
valley rafter	cabrio de la lima hoya
vault	bóveda
wall plate	solera, viga collar

Español - Inglés

acabado	finish
albanega	spandrel
anillo	ring
aparejo	bond
aparejo de tizón	bondstone
aparejo esquina de pez	herringbone pattern
aparejo isodomo arcada	ashlar masonry
arco	arcade
arco fajón	arch
armadura	principal arch
armadura de cubierta	reinforcement
azuelada	truss
barro	hand hewn
bóveda	mud
bóveda de cañón	vault
bóveda de crucería	barrel vault
bóveda de crucería	ribbed vault
bóveda de lunetos	groin vault
cabrio	underpitch vault
cabrio de la lima hoyo	rafter
caja y espiga	valley rafter
cal	mortice and tenon
can	lime
caña chancada	lookout
canalón	flattened cane reed
cercha	gutter
cielo raso	(structural) arch
claustro	false ceiling
clavija	cloister
codal	peg
columna	collar beam
	column

columnata	colonnade
contrafuerte	buttress
cornisa	cornice
coro	choir
correa	purlin
costura	joint
crujía	bay
cumbrera	ridge beam, ridge purlin
cúpula	dome
derrame	splay, jamb
durmientes	sleepers
elevación	elevation
enjuta	spandrel
enlistonado	lathing
enlucido	fi nish coat (plaster)
escalera de caracol	spiral stair rubble
escombro	facade
fachada	fi nish ceiling
falso cielo	subfl oor
falso piso	subfl oor
falso suelo	frieze
friso	pediment
frontis	course
hilada	niche
hornacina	leather strap
huasca	joint
junta	joint
llaga	brick paver
ladrillo pastelero	hip
lima tesa	batten, cleat
listón	lunette
luneta	

machihembrado	tongue and groove
mampostería	masonry
mampostería escuadrada	ashlar masonry
mampostería hilada	coursed masonry
mampostería ordinaria	rubble masonry
a media madera	half lap (joint)
ménsula	corbel
mocheta	pier
mortero	mortar
mortaja y espiga	mortice and tenon
muro de carga	bearing wall
muro divisorio	cross wall
nave central	nave
nave lateral	aisle
nudillo	collar tie
nudo	joint
pare	rafter
parhilera	ridgepiece
pavimento	flooring
pechina	pendentive
pendolón	crown post
perpiaño	bonder
pies derecho	post
pilar	pillar
plano	plan
punte	stringer
puntales	shoring
retablo	altarpiece
riñón	spandrel
ripio	rubble

sección transversal	cross section, section
sobrecimiento	base course
solera	wall plate, sill
sotocoro	space or area below the choir loft, in a church
tabique	partition
taco	blocking
tarrageo	plaster
teja árabe o curva	Spanish tile (also called Mission tile in the US)
tejado	roofing
tequillo	lath
terrazza	terrace
tímpano	tympanum
tirante	tie beam
transepto	transept
tornapunta	brace
ubicación	site plan
vestíbulo	entranceway
viga	beam, rafter
viga collar	wall plate, sill
viga cumbrera	ridge beam, ridge purlin
viga de tejado común	common rafter
viga de tejado principal	principal rafter
viga peraltada	girder
vigueta	joist
yeso	gypsum
zaguán	entry hall
zócalo	base, plinth

References

- Álvarez, Teresa, Joaquín Blasco, Talía Bugel, José A. Gálvez, Óscar Ramírez Molina, and Liam Rodger, eds. 2007. *Larousse gran diccionario Inglés-Español, Español-Inglés*. México, D.F.: Ediciones Larousse.
- Harris, Cyril M. 1977. *Illustrated Dictionary of Historic Architecture*. New York: Dover Publications, Inc.
- Harris, Richard. 1993. *Discovering Timber-framed Buildings*. Buckinghamshire: Shire Publications, Ltd.
- Menéndez Martínez, Carmen and Isabel Salto-Weis Azevedo, 1992. *Diccionario temático de arquitectura urbanismo y construcción = Topic dictionary of architecture, urbanism, and construction*. Madrid: Fundación General de la Universidad Politécnica de Madrid.
- Orosco Arce, Gonzalo, Guadalupe López Paredes, Gissel Villarrel Villazón, and Marco Antonio Macías Abasto. 2002. *Diccionario arquitectónico ilustrado*. Cochabamba: Centro de Conservación del Patrimonio Artístico y Arquitectónico "RESTAURO".
- Pérez Calvo, Carlos E. 1979. *Diccionario ilustrado de arquitectura*. Bogotá D. E.: Jorge Plazas S. Editor, Ltda.
- Pevsner, Nikolaus, John Fleming and Hugh Honour. 1975. *Diccionario de arquitectura*. Madrid: Alianza Editorial.



The Getty Conservation Institute